

VOL. 131, NO. 3

MARCH, 1967

NATIONAL GEOGRAPHIC

SIBERIA: RUSSIA'S FROZEN FRONTIER

DEAN CONGER 397

THE NATIONAL GALLERY AFTER A QUARTER CENTURY

JOHN WALKER 348

IN QUEST OF BEAUTY—A PORTFOLIO OF FRENCH PAINTINGS

PAUL MELLON 372

SQUIDS: JET-POWERED TORPEDOES OF THE DEEP

GILBERT L. VOSS, ROBERT F. SISSON 386

THE MOST MEXICAN CITY: GUADALAJARA

BART McDOWELL, VOLKMAR WENTZEL 412

"SNOWFLAKE," THE WORLD'S FIRST WHITE GORILLA

ARTHUR J. RIOPELLE, PAUL A. ZAHL 443

NATIONAL GEOGRAPHIC SOCIETY

WASHINGTON, D. C.

Organized "for the increase and diffusion of geographic knowledge"

GILBERT HOVEY GROSVENOR
President, 1870-1872; Editor, 1870-1874
Chairman of the Board, 1872-1876



The National Geographic Society is chartered in Washington, D. C., in accordance with the laws of the United States, as a nonprofit scientific and educational organization for increasing and diffusing geographic knowledge and promoting research and exploration.

Since 1890 the Society has supported more than 350 explorations and research projects, adding immeasurably to man's knowledge of earth, sea, and sky. It diffuses this knowledge through its monthly journal, *NATIONAL GEOGRAPHIC*; more than 26 million maps distributed each year; its books, globes, and atlases; 90 School Bulletins a year in color; information services by press, radio, and television; technical monographs; timely exhibits from around the world in Explorers Hall; and now a nationwide series of programs on television.

Articles and photographs of travel, natural history, and expeditions for far places are desired. For material used, generous remuneration is made.

MELVILLE BELL GROSVENOR, President and Editor
MELVIN M. PAYNE, Executive Vice President and Secretary
ROBERT V. FLEMING, Vice President and Treasurer
FREDERICK G. VOSBURGH, Vice President and Associate Editor
LEONARD CARMICHAEL, Vice President for Research and Exploration
ROBERT E. DOYLE, Vice President and Associate Secretary
THOMAS M. BEERS, Vice President and Associate Secretary
GILBERT M. GROSVENOR, Vice President and Senior Assistant Editor
VERNON H. BREWSTER, OWEN R. ANDERSON, HERMAN J. A. C. ARENS, WM. T. BILL, HERBERT T. HENDERSON, W. E. ROSCHER, C. VERNON SANDERS, Associate Secretaries
HILLEGARY F. HOSKINSON, Deputy Treasurer and Assistant Secretary
ARTHUR B. HANSON, General Counsel

COMMITTEE FOR RESEARCH AND EXPLORATION

LEONARD CARMICHAEL, Chairman
ALEXANDER WITMORE, Vice Chairman
MELVIN M. PAYNE, Vice Chairman
Rear Adm. L. O. COLBERT
CARYL P. HASKINS
A. REMINGTON KELLOGG, Research Associate
Smithsonian Institution
Vice Adm. EMORY S. LAND

T. DALE STEWART, Senior Scientist
Office of Anthropology
Smithsonian Institution
MATTHEW W. STIRLING, Research Associate
Smithsonian Institution
JAMES H. WAKELIN, JR.,
CONRAD L. WIRTH
PAUL A. ZAHL

and the Senior Officers of the Society:

BARRY C. BISHOP, Secretary

BOARD OF TRUSTEES

THOMAS W. McKNEW, Chairman of the Board, formerly Executive Vice President and Secretary (1952-1962)
LEONARD CARMICHAEL, Vice President
National Geographic Society
LEO OTIS COLBERT, Rear Admiral, U. S. Coast and Geodetic Survey, Retired
ROBERT V. FLEMING, Advisory Chairman of the Board and Chairman, Executive Committee
Riggs National Bank
CRAWFORD H. GREENEWALT, Chairman of the Board, E. I. du Pont de Nemours & Company
GILBERT M. GROSVENOR, Senior Assistant Editor
National Geographic
MELVILLE BELL GROSVENOR, Editor, National Geographic
CARYL P. HASKINS, President, Carnegie Institution of Washington
EMORY S. LAND, Vice Admiral, U. S. Navy, Retired, Formerly Pres., Air Transport Assoc.
CURTIS E. LEMAY, Former Chief of Staff, U. S. Air Force
H. RANDOLPH MADDOX, Vice President, American Telephone & Telegraph Company (Ret.)
WM. McCHESNEY MARTIN, JR., Chairman, Board of Governors
Federal Reserve System
BENJAMIN M. McKELWAY, Editorial Chairman, Washington Star
Asst. Secretaries: CHARLES P. BIXEL, RAYMOND T. McELIGOTT, JR., Asst. Treasurer: WILLIAM H. McCAULEY
HERMAN J. A. C. ARENS, Executive Assistant, LEONARD J. GRANT, Editorial Assistant, and Judith N. Dixon, Secretary to the President and Editor; Lenore W. Kesler, Secretary to the Chairman of the Board

MELVIN M. PAYNE, Executive Vice President
National Geographic Society
LAURANCE S. ROCKEFELLER, Chairman of the Board, Rockefeller Brothers, Inc., and President
Jackson Hole Preserve
JUAN T. TRIPPE, Chairman of the Board
Pan American World Airways
FREDERICK G. VOSBURGH, Assoc. Editor, National Geographic
JAMES H. WAKELIN, JR., Former Asst. Secretary of the Navy for Research and Development
EARL WARREN, Chief Justice of the United States
JAMES E. WEBB, Administrator, National Aeronautics and Space Administration
ALEXANDER WITMORE, Research Associate
Smithsonian Institution
LLOYD B. WILSON, Honorary Board Chairman, Chesapeake & Potomac Telephone Co.
CONRAD L. WIRTH, Former Director
National Park Service
U. S. Department of the Interior
LOUIS B. WRIGHT, Director, Folger Shakespeare Library

NATIONAL GEOGRAPHIC MAGAZINE

MELVILLE BELL GROSVENOR, Editor
MELVIN M. PAYNE, Executive Vice President
FREDERICK G. VOSBURGH, Associate Editor
FRANC SHOR, Associate Editor

EDITORIAL STAFF

Senior Assistant Editors:
Allan C. Fisher, Jr., Gilbert M. Grosvenor, John Scofield
Assistant Editors: Andrew H. Brown, Newman Barnstead, James Curran, Robert L. Conly, Edward J. Linehan, Kenneth MacLeish (Foreign Staff), Carolyn Bennett Patterson, Howell Walker, Kenneth F. Weaver
Senior Staff: Lontelle Alkman, Jules B. Billard, Leonard J. Grant, William Graves, Stuart E. Jones, Robert P. Jordan, Joseph Judge, Nathaniel T. Kenner, Howard La Fay, Samuel W. Matthews, Bart McDowell
Senior Natural Scientist: Paul A. Zahl
Foreign Staff: Linn Marden (Chief); W. Robert Moore (Emeritus), Thomas J. Abernethy, David S. Boyer, Helen and Frank Schneider, Volkmar Wentzel, Kap Ross (Research)
Editorial Staff: Wayne Barrett, Thomas Y. Canby, Louis de la Haba, Rowe-Findley, Joanne M. Hess, Wetton Janney, Jay Johnston, Elizabeth A. Moize, O. Mac White, Peter T. White, Virginia H. Finnegan, Alice J. Hall, Winifred M. Myers, Shirley Neff, Berry T. Sanborn (Asst.); Dorothy M. Coeson (Indexes); Rosalie K. Miller, Jeanne S. Duker (Files); Mary W. McKinney
Editorial Layout: Howard E. Payne (Chief); Charles C. Uhl, John M. Lacey
Book Service: Merle Severy (Chief); Edwards Park (Assoc. Chief); Seymour L. Fishbein (Asst. Chief); Ross Bennett, Anne Dirken Kobot, Patricia Coyle Nicholson, John J. Putman, Berry L. Reece, Jr.
Geography Art: Newman Barnstead (Chief); William Palmstrom (Asst. Chief); Anson Lisa Bigonachi, Gilbert H. Emerson, Victor J. Keller, John W. Lohars, Robert C. Maggs, Robert W. Nicholson, Isaac Ortiz
Research: George W. Beatty, Walter O. Crowe, John D. Garat, Jean B. McConville, Dorothy A. Nicholson, Eugene M. Schuel, John P. Wood
Special Publications: Robert L. Brenden (Chief); Donald J. Crump (Asst. Chief); Bruce Brandt, Johanna G. Farren, Mary Ann Harrell, Geraldine Linder
Editorial Research: Margaret G. Blodoe (Chief); Ann K. Wender (Asst. Chief); Idich C. Berg, Abigail T. Britt, Lillie L. Dinamore, Margery G. Dunn, Jan Holderness, Levenia Loder, Elisabeth J. Norton, Frances H. Parker, Patricia Rosenberg, Elizabeth C. Wagner
Geography Research: George Croussette (Chief); Newton V. Blakester (Asst. Chief); Leon J. Camova, Marguerite Ladd, Virginia A. LeVasseur, John A. Weeks
School Service: Ralph Gray (Chief); Arthur P. Miller, Jr. (Asst. Chief), Lea Ridgley Fuller, Charles H. Sloan, Janis Knudsen Whitt
News Service: Windsor P. Booth (Chief); Matt C. McDade (Asst. Chief), Edward Carmish, Sabur Robbins, Paul Sampson, Isabel Clarke (Asst.)
Education Service: Robert C. Dorle (Chief); Dennis B. Kane (Asst. Chief); David Cooper; Patricia F. Northrop (Asst.)
Photographers: Robert C. Ellis, Jr. (Chief); John McConnell (Asst. Chief); Elizabeth L. Donley
Library: Virginia Carter Hills (Librarian); Margery K. Barkdull (Asst. Librarian); Melba Barnes, Vera Cassilly, Karoline P. O'Donnell, Louise A. Robinson, Esther Ann Manion (Librarian Emeritus)
Editorial Administration: Patricia M. Watkins

ILLUSTRATIONS STAFF

Illustrations Editor: Herbert S. Wilbats, Jr.
American Illustrations Editor: W. E. Gastert
Art Editor: Andrew Poggenpohl
Asst. Illust. Editor: Mary S. Grunwald, Thomas R. Smith, Charles Allmon (Incoming Photographs), Layout and Production: Arthur A. Terry
Director of Photography: Robert E. Gilks, Asst. Director: Joseph Baylor Roberts, Film Review: Albert Moldvay (Chief); Guy W. Starling (Asst. Chief)
Photographers: B. Anthony Stewart (Chief); William Albert Allard, James P. Blair, Dean Conger, Bruce Dale, John E. Fletcher, Otis Imboden, Bates Littlehales, George P. Mobley, Winfield Parks, Joseph J. Scherschel, Robert F. Sisson
Picture Editors: Bryan Hodgson, O. Louis Mazzarella, Charlene L. Murphy, Robert S. Patton, Jon T. Schneberger, Librarians: Alan J. Lessel, Barbara A. Shattuck (Asst.)
Photo Lab: Edwin L. Wisland (Chief); Milton A. Ford, Donald McBain, Robert S. Oakes, Claude E. Pettone, Carl M. Shrader
Picture Research: Walter Meavers Edwards (Chief)
Artists: Walter A. Weber (Naturalist), Peter V. Bianchi
Engraving & Printing: Dee J. Andrella (Chief); Joe M. Barlett, Frank S. Oliverio, William W. Smith, James R. Whittier

CARTOGRAPHIC STAFF

Chief Cartographer: William Chamberlin
Associate Chief Cartographer: Alton D. Grazzini
Asst. Chief: William T. Peele, Map Compilations: Charles L. Stern (Supervisor); James W. Killian, Name Compilations: Richard J. Darley (Supervisor); Donald A. Jaeger, Manuela G. Kogutovics, George E. Stuart, Map Drawings: Douglas A. Strobel (Supervisor); John J. Boehm, Robert W. Northrop, Thomas A. Wall, Map Editing: Ted Dachetta (Supervisor); Russel G. Fritz, Richard K. Rogers, Thomas A. Walsh, Proofreaders: David W. Cook, Layout and Design: John F. Dorr, Harry C. Sildley, Administrative Assistant: Catherine M. Hart

SECRETARY'S STAFF

Administrative: Edwin W. Soeder, Richard E. Pearson, Accounting: Jay Givens, George F. Fogle, Alfred J. Harte, William H. McGhee, Martha Allen Bagger, Cashier: Frank S. Delle, Stationery: Everett C. Brown, Thomas M. Kent, Procurement: J. F. M. Johnston, Robert G. Cory, Sheila H. Immel, Margaret A. Shearer, Periodical and Retention: Joseph B. Hogan, Membership Research: Charles T. Kneeland, Membership Fulfillment: Ray J. Klockenbrink, Promotions: Stan Jennings, E. M. Pusey, Jr., Gordon Young, Phyllis Greene, Personnel: James B. Mahon, Adrian L. Ledon, Jr., Nellie E. Sinclair, T. Joyce Watts, Medical: Thomas L. Hartman, M. D., Explorers Hall: T. Keilor Bentley (Curator-Director)

EUROPEAN OFFICE

W. E. Roscher (Associate Secretary and Director), 11 Stanhope Gate, Mayfair, London, W. 1, England

PARIS OFFICE

Jacques Ottier, 6 rue des Petits-Pères, Paris 2^e, France

ADVERTISING

Director: Harley L. McDermitt, 630 Fifth Ave., New York, N. Y. 10020
Managers—Editors: William A. Boeger, Jr., Asst. Editors: John R. Weig, New York, Midwestern: William Turgeon, Chicago, Los Angeles: Jack V. Sheehan, San Francisco: Thomas Martz, Automotive: Joseph T. Feeney, New York, Travel: Robert W. Hazan, New York

COVER: First known albino gorilla comes to light in Rio Muni (page 442). PHOTOGRAPH BY JORGE GARCIA OF ICI S.A.

Copyright © 1967 National Geographic Society, 1201 and M Street, N.W., Washington, D.C. 20005. All rights reserved. Reproduction in any form or by any means without written permission is prohibited. Printed in U.S.A. Subscription postage paid at Washington, D.C. and at additional mailing offices. Cover design and title selected by editorial staff. NGS 4-1967, 8110-1 mag.

Canada's Centennial

A year of excitement and spectacle



1,500-mile Voyageur Centre Race & Regatta



FESTIVAL CANADA — spectacular theater from coast-to-coast



Highland Games



CANADIAN ARMED FORCES TATTOO — re-enacting history in over 40 cities



Essex Mod — St. Ann's — Nova Scotia — Aug. 8 - 12

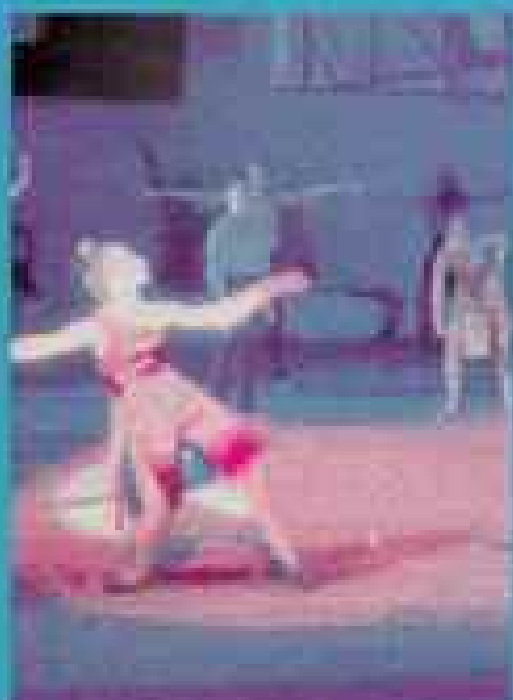

New ballets, operas, music



EXPO 67, Montreal — greatest International World's Fair ever — over 30 nations taking part — April 28 - Oct. 27

Canadians everywhere are celebrating. It's the hundredth birthday of Canada's Confederation. The party is nation-wide . . . saluting the past and visioning a great future.

Over twenty-six hundred new areas of culture and recreation have been built to commemorate the occasion. New plays have been written. New ballets, symphonies, films and books. Sports will be on a scale unequalled anywhere. Over 15 world championship meets alone.

A special Confederation Train will tour the land featuring a unique electronic display . . . Canada from ice age to space age.



A Military Tattoo — dramatically portraying 300 years of military history — will move across the country performing in 42 major cities. This will be coupled with air shows, Musical horse rides, Naval assemblies. And much more. For a memory you'll treasure — join us in Canada for Centennial. Share a quick look at the past . . . and look ahead with us to a future's promise. Canada is on parade. The welcome mat is out . . . coast-to-coast . . . all year long.

For information on Canada and our Centennial Year, write: Centennial Commission, P.O. Box 1967, Ottawa, Canada.



Pontiac Motor Division

With an OHC 6 like this who needs an 8?

The dapper stripe gracing the flanks of this Le Mans hardtop identifies it as our phenomenal Sprint option. This means its standard 165-hp Overhead Cam Six has been replaced with an even more enthusiastic 215-hp 4-bbl version. Special suspension has been added. And an all-synchro 3-speed floor shift.

The result is a high-rpm driving machine that'll go all day at highway speeds with plenty of reserve for passing. Yet with the agility and grace of a European sports car, and the reliability of American engineering. And you can

get it at a fraction of the European cost.

You can order the Sprint option on any Tempest or LeMans, except wagons. And, incidentally, they all come with a standard safety package that includes front seat shoulder belt anchors, four-way hazard warning flasher, and GM's energy absorbing steering column.

Of course, you don't have to go for the Sprint. The standard 165-hp OHC 6 is enough to send a lot of V-8s home counting their cylinders.



MARK OF EXCELLENCE

Pontiac OHC Sprint / Ride the Wide-Track Winning Streak

Focus on a unique discovery

NEWEST CANDIDATE for the title of world's most appealing pet, the only known white gorilla clowns before the cameras of Dr. Arthur J. Riopelle (left) and Dr. Antonio Joneh Cuspinera, Barcelona zoo director.

Dr. Riopelle heads Tulane University's Delta Regional Primate Research Center near Covington, Louisiana, which investigates human problems by studying man's closest living relatives, the nonhuman primates. The center, with National Geographic Society support, had just launched a major study of the little-known lowland gorilla in Rio Muni, West Africa, when Dr. Riopelle received the electrifying news of a white, blue-eyed gorilla. The scientist tells the story on pages 442-48.

Thus your NATIONAL GEOGRAPHIC brings details and striking color photographs of another exciting discovery. Share such experiences with friends by nominating them for membership on the form below.



NATIONAL GEOGRAPHIC SOCIETY MEMBERSHIP

CHECK ONE

Mail to: The Secretary, National Geographic Society
Washington, D. C. 20036

\$6⁵⁰ CALENDAR YEAR 1967 MEMBERSHIP DUES INCLUDE
SUBSCRIPTION TO THE NATIONAL GEOGRAPHIC.

Annual dues in the United States and throughout the world are \$6.50 U.S. funds or equivalent. To compensate for international postage and exchange differentials, please remit: for Canada, \$7.60 Canadian funds (\$7 U.S. acceptable); for all other countries, \$8 U.S. funds or equivalent. 80% of dues is designated for subscription to the magazine.

Life membership for U.S. and its outlying areas, \$150 U.S. funds or equivalent; for Canada, \$162 Canadian funds (\$150 U.S. acceptable); for all other countries, \$200 U.S. funds or equivalent. Remittances should be sent direct to National Geographic Society.

5-67

I NOMINATE for Society membership the person named at left. (Use separate sheet for additional nominations.)

(GIFT MEMBERSHIP) I nominate and enclose \$_____ for dues of the person named at left. Send gift card signed.

I DESIRE INFORMATION concerning membership and the NATIONAL GEOGRAPHIC. (Fill in at left.)

NEW MEMBER

PRINT NAME OF AN INDIVIDUAL ONLY (MR., MRS., MISS)

STREET

CITY, STATE, ZIP CODE

MY NAME

PLEASE PRINT (MR., MRS., MISS)

STREET

CITY, STATE, ZIP CODE



Does this look like two weeks at the same old beach?

You can be there for just about what you'd spend for an ordinary vacation. In fact, for \$528*, you can have three weeks in Paris and nine fascinating countries in Europe.

Want to spend less? "Mr. Information", your travel agent, can show you even lower cost tours. He'll let you browse through TWA Worldwide Adventure folders that cover all the popular cities and resorts abroad. When you've decided where, let him help you with the details. (Or mail the coupon and decide right at home.) Then it's TWA to London, Paris, Rome, Frankfurt, Milan,

Shannon, Zurich, Geneva, Lisbon, Madrid, or Athens, without changing terminals.

There'll be more than 140 TWA flights to Europe this summer. So no matter where you go—Scandinavia, Eastern Europe, Africa, Asia—the best way to begin is TWA. Wide screen color movies on most flights. Plus 8 channels of hi-fi and stereo. Even special language lessons. And you can charge your trip with our Worldwide Jet Credit Card.

Europe or the beach? Tough decision, isn't it?
Nationwide, worldwide...depend on TWA.



*Service mark owned exclusively by Trans World Airlines, Inc. Entertainment is optional at nominal cost. Films presented by Inflight Motion Pictures, Inc.
†Price per person includes round-trip 14-21-day group Economy Excursion fare from New York. Subject to government approval.

Welcome
to the world of
Trans World Airlines*



Please send me the following
free literature:

- Adventure Travel Plan
\$10-\$15 a-day
- European Motorcoach Adventures
- European Premium Adventures
- Iberian Adventures
- Air-Sea Adventures
- Student European Adventures
- European Car Purchase and
Rental Plan

TWA, Dept. 823, P.O. Box 25,
Grand Central Station, New York, N.Y. 10017

Name _____

Address _____

City _____

State _____ Zip Code _____

Telephone _____

My travel agent is _____

BRAND NEW MERCUISER 80!



MPH + MPG

New MerCruiser 80 outpulls, outruns and outaccelerates all other 80-HP stern drives—on less gas!

Efficient? Pound for pound, the new MerCruiser 80 packs more horsepower than anything in its class. Reason? A new high-performance design with die-cast aluminum block, head and manifold. This new MerCruiser weighs from 40 to 85 pounds less than other 80s—outruns and outaccelerates them on less fuel! Like to ski? An all-new drive unit, combined with props up to 14" in diameter, delivers plenty of low-end thrust to pop up skiers and get on plane fast. Rugged? This new 80 has all the dependable MerCruiser exclusives: shearproof drive, one-piece lower unit housing, Jet-Prop

exhaust, optional hydraulic shock absorbers and Power Tilt. A new alternator built into the flywheel eliminates belts and pulleys for greater safety, dependability and quiet. See the new MerCruiser 80—and 9 other new MerCruisers for '67, engineered to stay ahead: 60, 110, 120, 150, 160, 225, 325, 475 HP, and 60-HP diesel. See your MerCruiser dealer—or write for information to Dept. NG-3A, Kiekhaefer Corporation, Fond du Lac, Wisconsin.



WORLD LEADER IN MARINE PROPULSION

Kiekhaefer Corporation, Fond du Lac, Wis. Kiekhaefer Mercury of Canada, Ltd. Kiekhaefer Mercury of Australia Pty. Ltd. Subsidiary of Brunswick Corporation.

MERC **CRUISER** STERN DRIVES



**The world as it was. The world as it is.
Michigan is many summers, and they all happen at once.**

Old Fort Mackinac on Mackinac Island, where the first land battle of the War of 1812 was fought. You'll have to travel about here by horse and carriage. Would cars and concrete highways be fitting in such a setting? Greenfield Village near Detroit is much the same. Not a collection of objects ill-at-ease with each other, but a community that keeps the time of other centuries. Pure history. You'll understand our fondness for the past. But can you imagine a more magnificent passage to the present than the Mackinac Bridge that spans the straits between our two peninsulas? And didn't we manufacture most of the cars that cross it? The world as it was. The world as it is. Come for our many summers. They all happen at once.

MICHIGAN

Send for free Fun-Pak of vacation literature.
Michigan Tourist Council, Rm. 1103, Stevens
T. Mason Bldg., Lansing, Michigan 48926.

NAME _____

ADDRESS _____

CITY _____

STATE _____

ZIP _____

111 137 241

If they start as better ideas, they stay better ideas.

Here are four better ideas we came up with last year. Four Ford Motor Company exclusives you gave a good, running start. They're still better ideas. So you get them again in '67.



1 The two-way tailgate. Exclusive! Only Ford and Mercury wagons have it. Use the handle on the side, it opens like a door. Use the handle in the middle, it operates as a tailgate. Something else: you can get side-facing rear seats; makes a kid's playroom out of the back end.



2 4-way Emergency Flasher. On every Ford Motor Company car. When you are parked and you turn on the 4-way flasher—2 lights in the front blink on and off; 2 lights in the rear blink on and off. And this year, we put the switch right on the steering column. Handier than ever.



3 The Comfort Convenience Control Panel. Available only on Ford Motor Company cars. Individual lights flash on to tell you 1) that your doors aren't properly closed; 2) remind you to fasten your seat belts; 3) that you're low on gas; 4) that your parking brakes are still set.

4 Stereo-Sonic Tape System. Another first from Ford. Just snap in a tape cartridge and you have stereo sound surrounding you from as many as 4 speakers! Optional.



Ford Motor Company was first with these better ideas. And there are lots more where they came from for '67.



...has a better idea



Ten years from now, will he be 20 years older?

Some authorities say that we grow old too soon.

They believe it's possible to live at least 100 years, with the prospect of fewer disabilities.

At Parke-Davis, research is under way to learn more about many diseases that either age people prematurely or cut life short too soon.

We are seeking new knowledge about individual body cells. The more we learn about the growth of normal cells, the closer we may come to understanding abnormal cell growth or cancer.

We are seeking new knowledge about blood and why it sometimes clots within a vital artery of the heart or brain, causing heart attacks and strokes.

Perhaps there are new ways to protect people or make them more resistant to disabling or life-shortening conditions. Perhaps there are new ways to correct faulty body chemistry in time to prevent lasting damage.

In the research laboratories of Parke-Davis, we are looking for those ways every day.

PARKE-DAVIS
BETTER MEDICINES FOR A BETTER WORLD

Look what the Russians are building, just 40 miles from the U.S.A. As an American, you should look into it.



The U.S.S.R. hopes you will. You're invited to step right in, and take a look at life in the Soviet Union. Meet the people, see what they do for a living in Vladivostok or Minsk, and how they have fun.

What kind of ideas do the Russians have, about education, medicine, housing, industrial development, space exploration? You'll find out here. In the great Lunar Hall, they'll treat you to an eerie expedition to the moon. On the way, you'll discover what the feeling of weightlessness is like (just how is their secret).

And on the lighter side of things, you can see what the Moscow miss is wearing, at a fashion parade. Browse through nearby stores that sell the identical items you'd find in shops in Leningrad or Kiev. Drop into the 600-seat cinema and watch a Russian movie. And wind up in

one of the restaurants, where you can take your pick of specialties from every part of the country. (Incidentally, they've ordered 20 tons of sturgeon, eight tons of caviar and 28,000 litres of vodka, just for starters.)

The place to come for this fascinating experience is the U.S.S.R. Pavilion at Expo 67, Montreal, Canada. You'll find it just across the way from the giant U.S.A. Pavilion — another world of wonders. And a few steps away, the French, British, Italians, Japanese, Canadians — more than two thirds of all the nations on earth — spread before you the best of their arts and culture. The latest in science and technology. Their past, present and future.

In all, some 70 governments have spent hundreds of millions of dollars to make Expo 67 the greatest world exhibition of them all, and the first of its kind on this continent. It opens

on April 28th, for six wonderful months only. You'll find it the experience of a lifetime.

Start planning now. Expo 67 admission tickets at reduced advance prices save you up to 29³/₄, are on sale at banks, department stores, American Express offices, and wherever you see the Expo 67 sign. **Accommodations in Montreal?** No need to worry. LOGEXPO, the official accommodation bureau, guarantees you a place to stay, at government controlled prices. Reserve now — just write, mentioning dates and type of accommodations preferred, to LOGEXPO, Expo 67, Harbor City, Montreal, Quebec, Canada. Or see your travel agent. **Or write for free Expo 67 vacation planning information** to Expo 67 Information Services, 150 Kent St., Ottawa, Ont., Canada.

expo67
MONTREAL, CANADA

The Universal and International Exhibition of 1967
Montreal, Canada/APRIL 28-OCTOBER 27, 1967

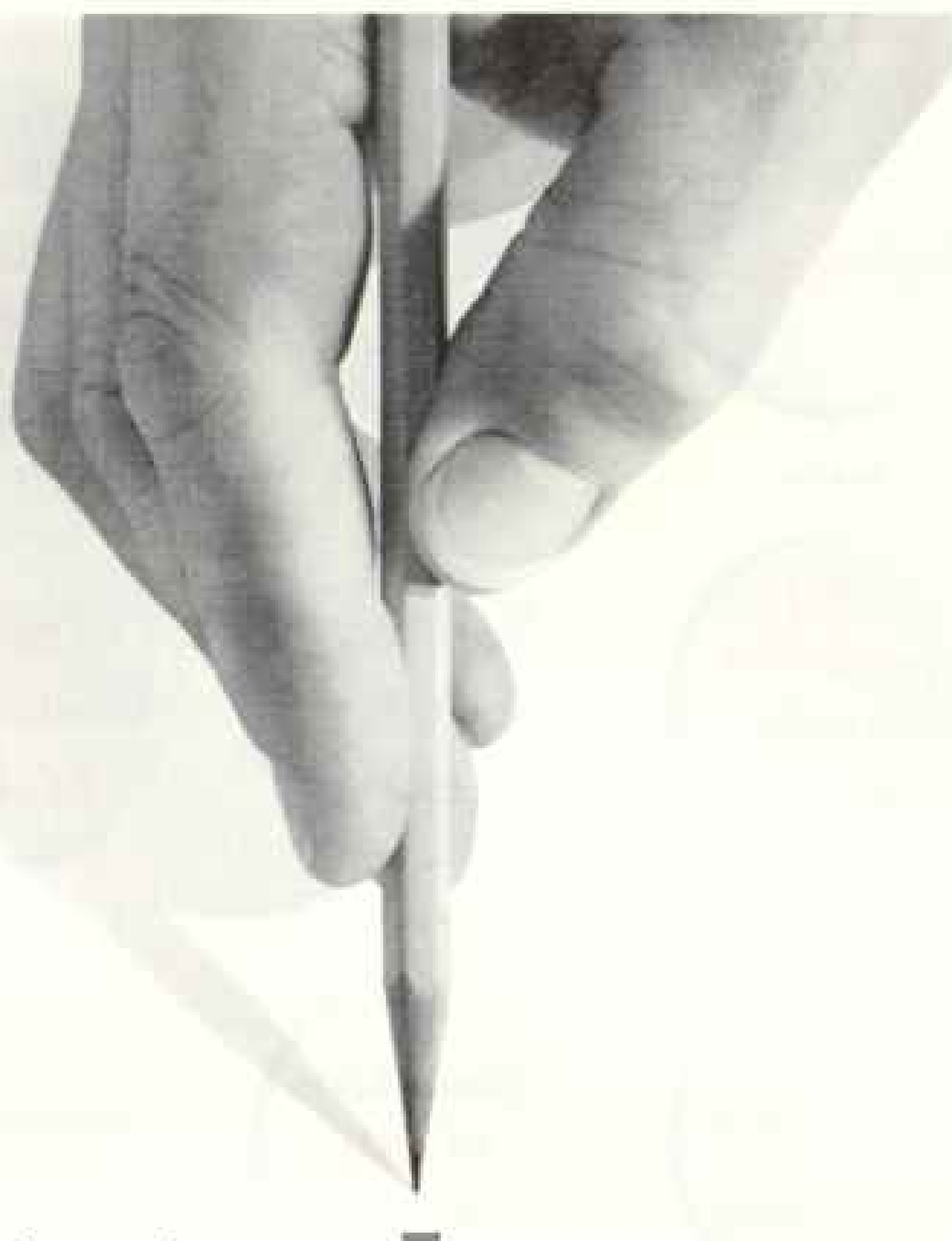

**When we set out
to revolutionize hearing aids,
this is all we came up with.**

This is the heart of tiny Zenith Hearing Aids. Our Micro-Lithic® circuit.

It's so small that 24 barely cover the face of a dime; yet it's so powerful, one performs like six transistors and 16 resistors to help restore the clear, full tone beauty of sound again.

If your hearing isn't quite as sharp as it used to be, please visit your Zenith Dealer. He'll be happy to show you some little things that make life worth living.

Zenith Radio Corp., Dept. 4P, 6501 W. Grand Ave., Chicago, Ill. 60635

Please send me your booklet, "An Informative Guide for the Hard of Hearing," plus Zenith Hearing Aid literature.

Name _____ Address _____
City _____ State _____ Zip _____

The quality goes in before the name goes on **ZENITH** HEARING AIDS



Arabic



Chinese



Danish



Dutch



Flemish



French

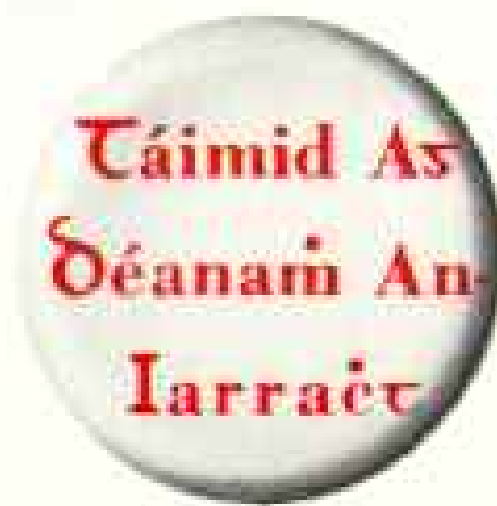

Gaelic



German



Greek



Hawaiian



Hebrew



Italian



Japanese



Norwegian



Portuguese



Spanish



Swedish



Tahitian



Thai



Welsh

Avis tries harder all over the world.



English

This ad might just ruin our image as the underdog in rent a cars.

But Avis has operations in 38 countries and we can't see keeping it a secret.

No. 2 is still what we are. And No. 1 is still ahead of us. Which means the Simca we rent in Nice has to be as clean as the Plymouth we rent in Newark.

We must say we had some trouble translating our Avis button. The closest the Germans can get to We Try Harder is, "We give of ourselves more effort."

In Italian, it comes out, "We will do more and better."

All of which is close enough to keep our foreign agents on the ball. (Wearing a sign saying that you try harder puts you on the spot to do it.)

If you'd like any of these buttons yourself, drop into an Avis agency. There's no car attached.

*You've worked hard
for this trip to Europe. Now
get everything you've worked for.*



You may have been thinking of a number of places—and airlines—for this trip abroad. There are certainly enough of both.

Picking the places is easy. And fun. But you should pick the airline with care. What do you look for?

First, an airline that goes where and when you want to go. You'll find that no airline has anywhere near as many flights to as many places as we do.

And you want all the trimmings, too. Memorable cuisine, for one thing. (Ours is by *Maxim's of Paris*.) And service that really makes you feel welcome. And comfort.

But there's something else you want, too. Something less definable, but more important than all the rest. And that's the good feeling that's yours only when you know you're flying the very best there is: the world's most experienced airline.

You've worked hard for this trip to Europe. So plan it with your Pan Am® Travel Agent. Or us. And get everything you've worked for.

World's most experienced airline

First on the Atlantic First on the Pacific First in Latin America First Round the World





YOU'LL WANT TO TAKE PART OF NEW BRUNSWICK HOME WITH YOU... GO AHEAD

It's all yours. All the beauty, wonder, history and fun of New Brunswick are yours to enjoy. For sea bathing, you'll find the warmest salt water north of the Virginia Capes; summer temperatures average 70°. Spectacular scenery hugs the coastline dotted with salty fishing villages and snug little harbours.

This is enough to make your trip unforgettable. But there's so much more. Journey inland to the lush river valleys and rolling countryside. The salmon fishing is superb. The trout are biting too. As you continue through New Brunswick,

you'll come face to face with some of nature's true wonders—like the Reversing Falls at Saint John, the Magnetic Hill near Moncton, and the great Tidal Bore on the Petitcodiac River. And don't forget the famous old cities. Handsome and serene with their early Canadian architecture, fine art galleries and museums. Here's where you'll find unusual gift ideas, antiques and fascinating shops.

Then, take it all home with you—in pictures, in souvenirs, in your heart. Remember your dollar goes farther in Canada. Write now for complete details.



NEW BRUNSWICK

FREE VACATION KIT

Send my New Road Map and Colorful "Where to Stay", "What to See" Books to:

Name _____

Address _____

Town _____ State _____ Zip _____

MAIL TO N.B. TRAVEL BUREAU, BOX NO. 11, FREDERICTON, N.B., CANADA

Ole!

BRAVO! Thrill to gay Spanish dances—there's a new world of excitement awaiting you in New Mexico . . . Old World Atmosphere . . . New World Charm . . . there's added spice to life here . . . blending the best of three cultures . . . Indian, Spanish and Anglo . . . we call it the Land of Enchantment . . . You will, too . . . Ole!*

* Bravo!



LIVELY, COMPELLING Spanish rhythms give the sparkling performance of our dances.

NEW MEXICO



FREE: For colorful literature about New Mexico, write Department of Development, Box NG-17, Santa Fe, New Mexico. Be sure to include Zip Code in your return address.



RELAX AMONG the sinistral lakes in cool, scenic beauty.



YOU'LL ENJOY the horse racing against majestic Western mountain backdrops.



STRINGS OF RED chiles dry against white walls.



NEW MEXICO OFFERS a wide variety of delightful accommodations for every taste.

The sophisticated camera that's "simple" minded.



The KODAK INSTAMATIC 804 Camera knows it all—and makes it easy. You never do any figuring. A built-in computer does it for you, setting the correct exposure automatically. For daylight *and* for flash.

Practically everything else about the 804 is automatic, too. Automatically, it adjusts for the speed of the film, advances the film after each shot, tells you when to use flash, switches to flash speed when you pop

on a flashcube, and turns the cube for the next shot. To load the 804, just drop in the film cartridge. To focus, use either the rangefinder or the quick "zone" settings. The lens is a sharp, fast $f/2.8$.

Shouldn't you be clicking with the automated precision camera that lets you concentrate on the fun side of photography? Less than \$130 at your Kodak dealer's.

Price subject to change without notice.

The Kodak Instamatic[®] 804 Camera





Wilma Marsh was a "nurse" when she was seven.

Now she's a nurse...for real...at General Motors.



There was a big difference between playing nurse and Wilma Marsh's first day as a nurse's aide at St. Joseph's Hospital in Flint, Michigan. When ordered to give a patient a bath, she fainted. Coming out of it, Wilma heard the doctor's remark, "This kid is never going to make it as a nurse."

That's when she made up her mind. "Wilma will make it!"

That was some 12 years ago, and Wilma has been in nursing ever since. Upon graduation from St. Joseph's she worked there for about 10 years. Now she's a full-time nurse at one of the Buick plant's 12 medical stations.

Her work is providing on-the-spot nursing service to employees with medical problems. Like all GM nurses, Wilma works under a doctor's guidance. She is well trained, capable, experienced and dedicated to her profession.

Nurses like Wilma Marsh are very special people at GM.

General Motors is people making better things for you.





méxico

is a colorful carriage ride,
an unexpected serenade,
a fiesta every day.

There's more to do in Mexico.

Mexico is a thousand and one things to do... all in one place. Mexico is music... everywhere. Mariachis and marimba bands

and strolling guitarists. In the parks, on the beaches, in restaurants and hotels, Mexico is the excitement and variety of innumerable bazaars where you can buy everything from inexpensive gifts and toys to top craftsmanship in ceramics, textiles, leather goods, paintings, silver, jewels, rugs... and paper flowers. There are superb restaurants serving French, Italian, Spanish, Portuguese, American and true Mexican gourmet cuisine. And the hotels? Everything from the most modern buildings to remodeled

castles. Balconies with magnificent views. Colorful patios. Intimate lounges. And you can fly inexpensively from Mexico City to any one of the coastal resorts in an hour or two at the most. It's easy to combine an afternoon of shopping or sightseeing in bustling Mexico City with an evening on the beach sipping a cool drink from a coconut shell. Or just get away from it altogether on a leisurely Caribbean island or in romantic out-of-the-way Mexican towns. The excitement and gaiety of metropolitan Mexico will always be there to come back to. There really *is* more to do in Mexico.

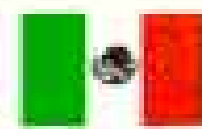

Contact your travel agent or
Mexico Information Office
DEPT. MG-01, 2 East 51st St.
N.Y. N.Y. 10022

Gentlemen:
Please send illustrated literature on Mexico.

Name _____

Address _____

City _____

State _____ ZIP _____



Home of the 1968 Olympic Games
Site of the 5th World Golf Championship, 1968
World Soccer-Football Cup, 1970
Mexican National Tourist Council
Mexican Government Tourist Department



Evinrude's new ROGUE is here! —the sea is calmer already.

That's the way it seems when you're in a Rogue.

Its Gull Wing hull helps cancel out the motion of the waves — instead of adding to it, the way conventional hulls do.

Her stabilizing sponsons resist the tendency to lurch and wallow — even in a following sea. There's no need to oversteer in one direction to overcome a yaw in another. The Rogue is a roomy 19-footer — but she feels more like a 25-footer. At trolling speed she rides easily and comfortably erect. A finger on the wheel keeps her on course.

At speed, she rides atop her own bow wave. The bigger the seas, the greater the shock-absorbing lift from the

scientifically contoured spray-riding tunnels molded into her hull. She's right at home out where the charter boats roam.

Her 200 hp V-8 purrs along with quiet authority and miserly economy. Flat out, she'll do an impressive 40 mph.

The Rogue is a party boat. Perfect for fishing parties when equipped with optional rear seat with built-in bait well and cooler. Back home, she's a plush pleasure boat for sociable entertaining.

But: a word of caution. Don't ride in a Rogue unless you intend to own one. The experience is apt to be habit-forming.

See the Rogue at your Evinrude dealer, listed in the Yellow Pages under "Outboard Motors." Catalog free. Write Evinrude Motors, 4075 N. 27th Street, Milwaukee, Wisconsin 53216.

EVINRUDE
first in  outboards
DIVISION OF OUTBOARD MARINE CORP.

This new GRAVELY Convertible Tractor makes tough jobs easy... simple jobs a pleasure!

Here's the power partner you've always wanted... the Gravely Convertible that gives you the best of both worlds. Now you sit back and ride through those big lawn areas... in command all the way. Your all-gear, no-belt drive gives you instant control, and that new Gravely engine gives you power to spare. Four speeds forward, four reverse... without clutching. Safe, comfortable, almost indestructible!

When the going gets rough... pull one pin and your rider converts to a walker. Takes to steep terrain like a mountain

goat... does the tough trimming, the gardening and rugged clearing jobs with ease.

Four-season performance... with your choice from 39 attachments that give you power to mow, plow, blow snow, haul or do any other lawn and garden job—better! For as low as \$27.07 a month*, you can own the new Gravely Convertible with 40" mower! See your Gravely dealer for exact price in your area. Send for our FREE CATALOG. Write now: Gravely, 5603 Gravely Lane, Dunbar, W. Va. 25064.

*After minimum down payment

 **GRAVELY**

TRACTOR DIVISION
Studebaker
CORPORATION

The newest in compact tractors from the oldest compact tractor manufacturer—1917-1967



COMMERCIAL-10

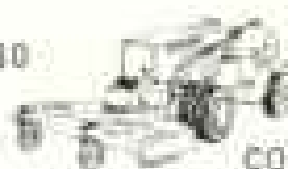

CONVERTIBLE

SUPER-L

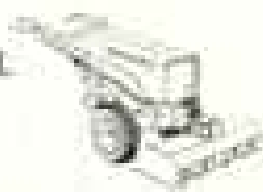

**Riding
Convenience**

**Walking
Versatility**

Higher Earnings on your SAVINGS



You earn
5.39%
at our current rate of
5.25%
if account held 1 year.

ASSETS OVER \$700,000,000

SAFETY—More than \$250,000,000 in accounts over \$10,000 each.

AVAILABILITY—High 14% liquidity ratio assures prompt availability of your funds.

SAVE BY AIR MAIL—We process promptly and pay air mail postage both ways.



NOW—GET A CHECK EVERY MONTH

Put your retirement funds—or other funds—to work in a Coast Federal Monthly Payout Plan account. You get a monthly check for as much as 10% per year of your opening balance*. Remaining funds continue to earn at Coast Federal's current high annual rate.

*Minimum opening balance \$6,000.00.

COAST FEDERAL SAVINGS

JOE CRAIL, PRESIDENT

To: Dick Waldronas, Coast Federal Savings and Loan Association, 5th & Hill, Los Angeles, Calif. 90014

Yes, I'd like to open a Monthly Payout Plan Type E account. Enclosed is my check in the amount of \$_____ I'd like to receive a monthly check in the amount of \$_____ to be mailed to me on the 1st of each month. (Your first check will be mailed to you the 1st of the month after your account is opened.)

Here's my passbook. Please transfer my account.
 Individual Account Joint Account NG3-67

Name(s) _____
(Please print)

Address _____

Zip _____

Make my check each month payable to _____

7-120A



Don't Climb Stairs

Put an end to climbing stairs. Ride safely, effortlessly from floor to floor in a Sedgwick home elevator or Stair-Chair®. Quick-RELAX...RIDE A SEDGWICK ELEVATOR

Sedgwick MACHINE WORKS
239 West 14th Street, New York 11
ESTABLISHED 1893

STAMPS FREE

New Issues—New Countries—Triangles
ROCKETS—OLYMPICS—SCOUTS
BIRDS—FLOWERS—ANIMALS—
ALSO Old Canadian and U.S. postage stamps. All genuine. Plus complete illustrated Canadian Stamp Catalog. All the above FREE. Please write.

GRAY STAMP COMPANY
Dept. N5 — Toronto, Canada

florida vacation capital DAYTONA BEACH resort area



Headquarter at the "World's Most Famous Beach" while visiting the major attractions of Central Florida. Enjoy swimming, sunning, surfing, or just plain relaxing on our 23 mile long beach. Thrill to the Daytona International Speedway . . . golf on 5 championship courses . . . fish from surf or pier . . . play tennis or shuffleboard. Dine in fine restaurants and enjoy accommodations to fit any budget.



FREE Full Color Brochure and Attractions Map.

DAYTONA BEACH
RESORT AREA
P.O. Box 2188, Dept. 4-11
Daytona Beach, Florida 32115

(Divided by the Oak, Grand Beach, Holly Hill, Daytona Beach, Daytona Beach Ocean, South Daytona, Port Orange, Ponce Inlet)

Name _____
Address _____
City _____ State _____

The wise men of Kyoto will impress you without a word; they're stone. The Thais will have you splashing yourself with water during the Songkran Festival. You'll find Hong Kong's "Repulse Bay," one of the world's loveliest beaches.

The Orient. 22 days. \$1,601.*

BOAC will take you on a tour of Japan, Thailand, Hong Kong, Taiwan and Singapore.

A tour of saffron-robed monks, exotic dancers, floating markets, feudal castles and jewel-encrusted temples.

\$1,601 includes your round trip by BOAC jet, all other transportation, fine hotels, most meals, sightseeing, escorts and tips.

For more information mail this coupon. Or see your Travel Agent.

*Based on Economy jet group inclusive tour, basing fare from New York, 30-day domestic excursion fare through April 23, 1967 and double occupancy in hotels.

British Overseas Airways Corporation
Dept. PT-45, Box VC 10
New York, N.Y. 10011

Please send me the "Orient Explor-A-Tour" brochure.

Mr., Mrs., Miss _____

Address _____

City _____ State _____ Zip _____

Travel Agent _____

BOAC TAKES GOOD CARE OF YOU

 **BOAC**

01-562



ONE THING FOR SURE...IT'S A CADILLAC.

The Fleetwood Eldorado has earned instant acclaim as the newest idea in luxury motoring. Its unique combination of front wheel drive, variable ratio power steering and automatic level control provides incomparable handling and performance. Its five-passenger luxury, its many interior conveniences and its unexcelled safety features provide a sense of satisfaction totally new to personal cars. And its poised elegance imparts an air of youthful dignity and daring that makes the Eldorado the most desired motor car of its kind. At the same time, it is completely a Cadillac in the way it performs, rides and looks. Drive the Eldorado soon. Learn what all the excitement is about at your authorized dealer's.



Fleetwood **ELDORADO** *by Cadillac*
WORLD'S FINEST PERSONAL CAR



MADE BY EXCELLENCE · Cadillac Motor Car Division



The Santiago, Mediterranean in Pecan.

Magnavox stereo...the magnificent way to enjoy the full beauty of music in your home.

ASTRO-SONIC STEREO brings you the full beauty of music with unequaled tonal dimension and fidelity from your records, or stereo FM and FM/AM radio. This superb performance is maintained with lasting reliability because advanced solid-state circuitry replaces tubes; eliminates component-damaging heat.

Exclusive Micromatic record player is exceptionally accurate—completely eliminates pitch distortion. Feather-light 1/10-oz. tracking touch banishes record and stylus wear so your records can last a lifetime.

And every authentic style is a furniture masterpiece you will admire and enjoy for years.



The Hallvard, in Walnut.

Magnavox is sold *direct* through franchised dealers (listed in the Yellow Pages) saving you middleman costs. Solid-state stereo console phonographs from \$149.50 and portable stereo from \$39.90.

the magnificent
Magnavox
270 Park Ave., New York 17, N.Y.



The Hatwick, in Maple.

INSIDE

What makes the new Merc 1100SS the world's most powerful, most advanced outboard?

⚡ NEW ALL-ELECTRONIC THUNDERBOLT PROVED IGNITION WITHOUT BREAKER POINTS. First on Mercury in 1966, finest by far in 1967—fires with lightning speed and power; eliminates pre-ignition. Polar-Gap spark plugs last seasons, not days. Engine efficiency and reliability are dramatically increased! No need for periodic adjustments to plugs and points—timing never needs resetting!

⚡ QUIET! Comes from Mercury's unique System of Silence: acoustically lined wraparound cowling, rubber-mounted engine support frame, neoprene-sealed fittings, "Wall of Water" exhaust jacket, Jet-Prop exhaust and Dyna-Float suspension. Add internal reed valves, Power-Dome combustion chambers, closer tolerances.

⚡ SMALL-BORE, SHORT-STROKE, IN-LINE DESIGN minimizes the major sources of engine wear, results in more horsepower per cubic inch, greater economy, longer engine life.

⚡ FIXED-JET CARBURETORS maintain a perfect air-fuel mixture—the engine can't run too rich or too lean.

⚡ ENDURANCE-PROVED CONSTRUCTION. Mercury's crankshaft and connecting rods are made of forged-alloy steel. Anti-friction ball-and-roller bearings are used throughout. Shearproof drive and hydraulic shock absorbers provide rugged impact protection.

⚡ JET-PROP EXHAUST fires exhaust sound and fumes through the propeller hub into the prop slipstream. Vacuum-caused drag is reduced, engine breathing improved.

See the 110-HP Merc 1100SS—plus 8 other new Mercs for '67—engineered to stay ahead: 3.9, 6, 9.8, 20, 35, 50, 65, 95HP—at your Mercury dealer—or write for '67 catalog to Dept. NG-3, Kiekhaefer Corp., Fond du Lac, Wisconsin.

Kiekhaefer Corporation, Fond du Lac, Wisconsin. Kiekhaefer Mercury of Canada, Ltd. Kiekhaefer Mercury of Australia Pty., Ltd. Subsidiary of Brunswick Corp.

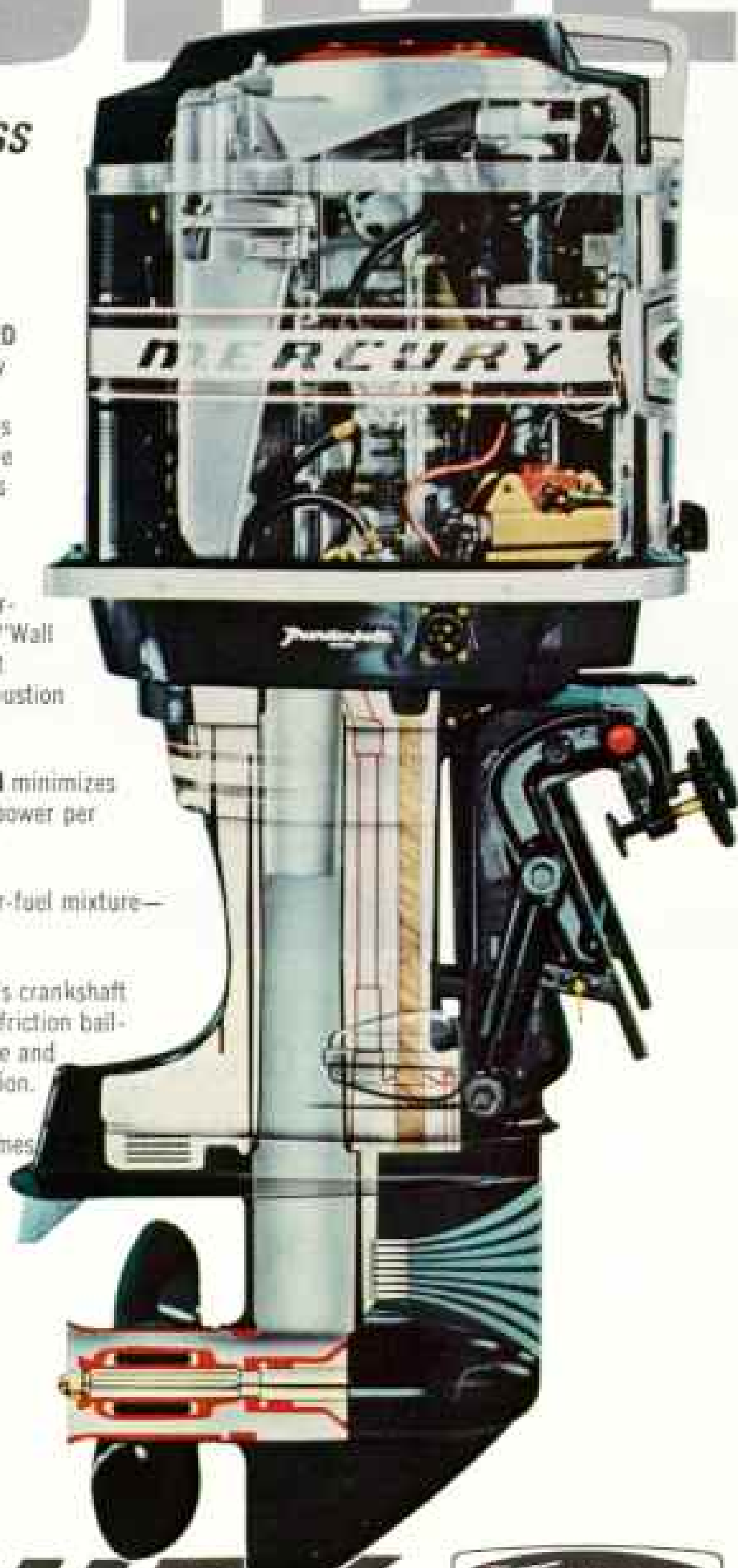

MERCURY



WORLD LEADER IN MAKING PROPELLERS

ANOTHER MERCURY FIRST: THUNDERBOLT IGNITION—Now without breaker points and available on 4 new Mercs—50 to 110 HP.



March, 1967

NATIONAL GEOGRAPHIC

THE NATIONAL GEOGRAPHIC MAGAZINE VOL. 67, NO. 3 COPYRIGHT © 1967 BY NATIONAL GEOGRAPHIC SOCIETY, WASHINGTON, D.C. INTERNATIONAL EDITIONS 1967



SIBERIA

Russia's Frozen Frontier

Article and photographs by DEAN CONGER
National Geographic Staff

WE HAD FLOWN northeastward for three hours through the star-blazed Siberian night. Since we had left Irkutsk, not a speck of light had pierced the darkness below. We might have been over an ocean, for all the signs of life under our wings. Then the plane glided earthward out of the black crystal sky, touched wheels to an ice-white runway, and rolled to a stop in front of the Yakutsk terminal.

I stepped out into air as still as ice but colder than any ice I had ever known. The temperature, our captain had

*FRIGID MURK
veils traffic
and pedestrians
in Yakutsk. In
winter, Siberia's
communities live
beneath a clinging
shroud of their
own "human-
habitation fog."*

ILLUSTRATION BY LEE BROWN,
VISUAL PRESS AGENCY (S. K. A. I.)



BRAVING A VAST DEEP FREEZE, trappers set out from Oymyakon, earth's coldest town. Hardy as the reindeer that clothe them and pull their sleighs, the Yakuts camp out in weather as bitter as -90° F. while trapping ermine, fox, muskrat, and sable in the frost-caked forest. With such people the Soviet Union thaws a land of the future from Siberia.

EXTRACTS BY DEAN CONSER © NATIONAL GEOGRAPHIC SOCIETY 299







told us, stood at 58° below zero Fahrenheit. And yet, amazingly, this breath-catching, face-burning, subarctic atmosphere was thick with fog.

Nowhere in nature does fog exist at temperatures far below freezing. Cold air is dry and clear, and this is as true in supercooled Siberia as in my native Wyoming—except where men and their works are gathered. For the frozen fog of Yakutsk, I discovered, is “human-habitation fog,” caused by the exhalations of people, their homes and buildings, their animals, and their machines. It is the fate of Siberian townsmen to live out each bitter, windless winter in a dense mist of their own making.

Romance Hampered by Winter's Grip

A hundred passengers, overcoated, booted, fur-hatted, scurried across squeaking snow toward the indistinct mass of the terminal. Here, a waiting room like others of its kind everywhere in the world contained a welcome warmth and a sizable number of cheerful, baggageless young men and women who were obviously not passengers.

Through my guide and interpreter, Yevgeniy Ruzhnikov (left), I asked the airport receptionist about them.

“There is no love on the streets of Yakutsk when the winter cold is upon us. Romantic midnight strolls must wait for warm weather. These young folk are on their way home from their club. Their route brings them past the airport,

Warm hospitality in a frigid land: The family of sculptor Semen Pesterov, second from right, feasts the author's party. Mrs. Pesterov offers *chokhon*, a frozen cheeselike delicacy, to Soviet journalist Yevgeniy Ruzhnikov, right, Mr. Conger's guide and interpreter. Working exclusively in ivory of the long-extinct mammoth, preserved in Siberia's permafrost, Mr. Pesterov shapes figures like the dashing horse-drawn sleigh below. His carving talent perpetuates an art of Yakut ancestors.



Probing secrets of permafrost, a scientist drills samples from a research cave that requires no shoring. Yakutsk's Permafrost Institute tackles the problem of unlocking natural treasures from perpetually frozen earth that underlies Siberia in places to depths of nearly a mile. The institute hopes to distribute natural gas without pipes—sending it through tunnels in the rock-hard ground.



and they've come in to get warm before walking the rest of the way to town."

For my own townward transportation a taxi was summoned, and arrived in its own good time. Entering it was like stepping into a comfortable closet, so thoroughly was the frozen world around us shut out. The windows were opaque with ice.

Yet the windshield remained clear. The driver explained. "Double panes, with an air space between. Winter is hard on cars here. We're lucky if they last two years. Sometimes the tires split open, and the metal gets so brittle that it cracks if you hit it.

"And winter is hard on drivers, too," he added. "I heard of a young man, traveling alone, who got his hand caught under a wheel while changing a tire. He tried to chew the hand off, but he froze to death before he could finish. Now people usually drive in groups."

I climbed at last out of the blindness of our claustrophobic cab onto a haze-smothered street where stucco buildings loomed dark and still. We entered the nearest of them, Yakutsk's main hotel, the Lena, through a sort of air lock of successive doors.

Luggage Sprouts Frost in Warm Hotel

The incredible Siberian cold followed me into the building to perform still another eerie trick: My aluminum suitcases, now ranged on the warm floor, turned white before my eyes—white with the same sparkling frost that coats a silver julep cup just out of a freezer. It was a great first-night finale. Satisfied that no further phenomena would top it before morning, I retired to my room.

There, behind a taped-up, triple-paned window and under an untuckable envelope of sheeting stuffed with blanket, I let my mind gradually catch up with my jet-accustomed body. Only yesterday I had been in Moscow, now six time zones away.* Before that I had traversed a fifth of the world in the long flight from Washington, D. C.

On an earlier Siberian journey my wife and I had circled the globe to visit four towns on the Trans-Siberian Railroad that were officially "open" to foreign tourists. Now I found myself, to my amazement, a welcome guest in remote, generally "closed" reaches of northeastern Siberia. This minor miracle was per-

formed by the Novosti Press Agency, which for a fee offers the services of its staff to foreign journalists.

All in all, a lot of travel—25,000 miles of it within Siberia itself (see the author's route, following pages, and the Atlas Map supplement, **Eastern Soviet Union**, distributed with this issue). And it had not been easy travel, for many barriers impede even supervised journeys in Russia. Yet a guided tour was the only way to get a good look at a land almost unknown to the Western World; a land as big as the United States and Mexico combined.

Siberian Breakfast: "Eyes" Straight Up

Yakutsk, now asleep around me in the frozen night, had been founded in 1632 as a fur-trading outpost of the old tsarist empire. Siberia—or Sibir, as Russians know it—was not a country then but a frontier region, and so it remains. Russians think of it much as Americans used to think of their West.

But Russian frontierland, like its American counterpart before it, is being infiltrated by modernity. Tomorrow's techniques modify the wilderness. In the morning I would see how science has changed the old traders' camp.

The Siberian breakfast is comfortingly similar to the American—toast, tea, sausage, and eggs. The latter, however, are always fried and served straight up in pairs and are called, with awful aptness, *glazunya*, from the word for "eyes." Mine fixed me with an orange stare that momentarily stayed my upraised fork. I like my eggs scrambled, but I found no scrambled eggs in Siberia.

At daybreak—after nine o'clock—Ruzhnikov and I set out for an interview with the mayor. Fur-hatted Yakuts hurried along the sidewalks, mittens to their faces. Buses, trucks, cars, and horse-drawn sledges filled the street with continuous traffic, reminding me that Yakutsk is a busy city of 89,000 and growing by the week.

As we left the center of town, stucco buildings gave way to unpainted wooden ones with low-pitched roofs (snowfall is light in this

(Continued on page 308)

*For other accounts of travel in Russia, see in the NATIONAL GEOGRAPHIC: "An American in Moscow," March, 1966, and "Firsthand Look at the Soviet Union," September, 1959, both by Thomas T. Hammond; and "Russia as I Saw It," by Richard M. Nixon, December, 1959.

Brittle awning of ice shades the windows of a community cafeteria in Oymyakon. Moisture in warm air escaping from the casements quickly freezes to create the canopy.





Onetime limbo for political exiles, Siberia today wears a new image as the world's greatest storehouse of untapped natural wealth. Cossack bands claimed the sparsely inhabited domain for the tsars nearly 400 years ago. But this land of nomads lay virtually fallow until the Trans-Siberian Railroad, stitched along Siberia's hem, opened a way for development. Now aircraft bring another era, putting remote communities, where no roads lead, in touch with the world.

Harking to the Pied Piper throb of a helicopter, children of Oymyakon crowd in for their first glimpse of an American—author-photographer Dean Conger (right). Frozen breath clouds his glasses and salts the fringe of his cap. To prepare this article, Mr. Conger logged 25,000 miles in Siberia during three trips, visiting many places seldom seen by Westerners.



OUTLINE OF CONTIGUOUS UNITED STATES SUPERIMPOSED ON SIBERIA.

SIBERIA

HALF AGAIN larger than the contiguous United States, Siberia spans nine time zones, yet holds fewer residents than New York State and New England combined. Slavs outnumber Asians nine to one in this pioneer region. Eight-month winters give way to short, sweltering summers that thaw topsoil into mosquito-breeding bogs.

AREA: 4,403,100 square miles. **POPULATION:** 23,358,000. Mainly Slavic; large minorities of Buryats and Yakuts; more than 20 smaller ethnic groups. **MAJOR CITIES:** Novosibirsk (pop. 1,029,000), important transportation center with heavy industry. Krasnoyarsk (pop. 341,000), transportation and industrial center. Irkutsk (pop. 401,000), hub of a growing industrial area west of Lake Baykal. **CLIMATE:** Extreme temperatures range from -96° to above 100° F. Winters mostly sunny; rainfall in the summer averages about 20 inches.



CONGERS/RE © N.A.S.

SITTING AT THE "POLE OF COLD," *Oymyakon* puffs into the dusk of midafternoon. Though south of the Arctic Circle, the community endures lower temperatures than towns farther north. Surrounding mountains block winds that might dispel its mantle of frigid air.

306 WINDLICHING BY DEPH CONICE © NATIONAL GEOGRAPHIC SOCIETY





semiarid region of Siberia) topped by television antennas. And everywhere the weird blue habitation fog softened the scene, blurring every detail, dimming every color.

"Watch your nose!" shouted a passerby. Ruzhnikov stared at me in alarm. "Your nose is white!" he cried. "Rub it! It is freezing!"

"Impossible," I told him, laughing. "We're only five minutes from the hotel." Then I noticed that my nostrils were clogged with ice and that every breath caused a stinging in my chest. Startled, I rubbed with a will. Circulation and color came back.

Picture taking in the -50°F . temperature

advanced the film to take another—and the film, frozen stiff, snapped.

As Ruzhnikov and I hurried on, we saw old log homes, weathered, unpainted, with fancy carving and fretwork around the windows and doors (page 312), many of them tilted at angles so odd as to suggest that their builders had been full of vodka. But in fact, Ruzhnikov explained, it was because they were built on ground that was full of frost.

Mayor Mikhail Semenov, in the welcome warmth of his office, developed this frosty theme further. Like all Yakuts, he was endlessly concerned with the weather.



ENTACHROME (OPPOSITE) AND AGOACHROME © N.G.S.

Luxurious coat assures this silver fox a pampered life at Oymyakon's state animal farm—until skinning time. Mostly black, the variety takes its name from a sprinkling of silver-tipped hairs. Its highly prized pelt probably will be shipped abroad, where furs earn the U.S.S.R. valuable foreign exchange.

Besides breeding foxes, the farm sends trappers into the *taiga*—coniferous forestland—to catch wild animals.

Face-framing fur sets off the beauty of a young mother and child in Irkutsk, crossroads of Siberia. Harsh weather makes furs almost a necessity for Siberians.

was even more difficult than keeping my nose alive. My camera hung inside my parka, and when I breathed down, it frosted up. If I blew my breath up, my glasses became white disks about as transparent as a pair of clamshells. To regain even a vestige of vision, I had to remove my down-filled mittens, then my knit gloves, then—wearing only my silk undergloves—pinch the middle of each lens to defrost a small spot in its center.

By the time I was ready, my fingers were numb. But I could still raise my camera, holding my breath so as not to obscure the viewfinder, and take a picture. Triumphant, I

"We have an eight-month-long winter, 300 miles south of the Arctic Circle," he told us, "with temperatures often reaching -76°F . The earth is frozen solid here to a depth of about 1,000 feet. But in summer it's hot—over 100° sometimes—so the top few feet thaw. When that happens, the old houses that sit right on the soil settle unevenly, as they do even in winter when their own heat melts the frost under them.

"But the thaw gives us a growing season, short as it is. We raise cabbages, potatoes, cucumbers, some wheat, and tomatoes. Oh, they never get red, but they are tomatoes.



"Also, in summer, when our river, the Lena, is free of ice, we can float our timber north to the Arctic Ocean. And, during the brief time that the river is open, our supplies are brought in by barge."

The mayor went on to talk about new construction—one of the most conspicuous activities in Yakutsk and, for that matter, everywhere in Siberia. Once a discussion turns to building, of course, it immediately returns to the subject of the permanently frozen ground, or permafrost.

"When we put up a new building now," the mayor said, "we put it on piles. At the moment we are building a seven-story hotel and many apartment buildings. Yes, we build even in winter. If we worried about the weather, we could work only four months of the year. But why don't you have a look at our construction methods yourselves?"

Habitation Fog Ends at City Limits

Vladimir Dynin, construction director of the Yakutsk Autonomous Soviet Socialist Republic, took us in his jeep to an apartment house being erected, where bundled-up men and women were laying bricks in spite of the 50-below-zero temperature. "The mortar is heated," he told us, "but if the weather gets much colder, the crane that lifts the mortar won't operate properly. That stops us."

I began to take pictures of the people at work. To my chagrin, I soon had to give up. This time the film held up, but my fingers did not. (The skin peeled off them ten days later.) I was forced to put my heavy mittens back on, while smiling women, who sensibly had kept *their* mittens on, continued to lay bricks.

As we left the city, bound for a building site beyond its limits, the fog suddenly ended and we emerged into a bright, crisp day, full of sunshine. We had escaped at last from the frozen exhalations of Yakutsk.

On the level land along the river, Dynin showed us a dozen huge spikes sticking out of the ground (right). "These are reinforced concrete piles. We use steam jets to thaw the permafrost and then, when the soil is mushy, we sink a pile down 23 feet. When the soil refreezes, the pile becomes part of the frozen ground. The buildings to be supported by the piles will be set six to eight feet above the ground, as if they were on stilts. The cold air will circulate under them and prevent their heat from melting the permafrost."

Curious about this phenomenon of the literally frozen north, we went to Yakutsk's Permafrost Institute. Its director, Pavel Melnikov, peered over the top of his glasses and talked about the problems frost causes.

"Even in summer permafrost affects us," he said. "Water from the thawed surface can't drain down, so in the warm season there are bogs over much of Siberia. Mosquitoes breed in them by the billions.

"But there are great natural resources—oil, natural gas, gold, tin, coal, black mica, and diamonds—in the permafrost, wealth for the taking, but in difficult situations that stimulate ingenious minds.

"For instance, we hope to pipe natural gas to Yakutsk and other communities—without pipes! We will attempt



Planting piles in permafrost, construction workers at Yakutsk first drape the concrete pillars with steam hoses. Jets of vapor melt the frozen soil around the shafts, allowing them to sink 23 feet into a temporary mush that soon refreezes. Apartments built on these piles will sit several feet above ground so their heat cannot thaw the granite-hard earth.

Foot-long cucumbers grow at the Yakutsk Botanical Gardens Experiment Station. This variety fruits without pollination. Siberians plan to overcome the short growing season with gas-heated bothouse gardens.



LETTERHEADS LIGHTS AND BROADCASTING © W.L.C.





to send it through tunnels in the permafrost. When we get gas, we will raise vegetables in big gas-heated hothouses."

Director Melnikov took us about 50 feet down into the institute's experimental cave. The floor crunched as we walked through this permanent natural deep freeze, the walls and ceilings of which were covered with frost. Its tunnels, cut through the frozen earth, needed no shoring (page 300).

Layer of Ice Keeps Water From Freezing

The director then spoke of mining gold in the frozen ground.

"We thaw the ground to dredge out the gold. It is a two-year operation. The first year we melt the surface, sometimes by solar energy. The area is then flooded with water, which freezes down to about seven feet. Insulated by this top layer of ice, the subsurface water continues the thawing during the winter. Early in March dredges break through the ice and the mining begins."

From the cave our way led through the fog

again to the office of the president of this largest of the Soviet Union's autonomous republics. In the Yakutsk A.S.S.R., as in others that reflect ethnic divisions, the people take pride in their racial and linguistic individuality.

Herself a proud Yakut, Madame President Aleksandra Ovchinnikova was born of poor, illiterate cattle breeders in the wilderness west of Yakutsk. She completed studies at a technical school, worked as an engineer, took her higher education by correspondence, and finally graduated in history (page 328). Now 52, she told me with obvious pride, "My son is a civil engineer and my daughter is a high-school chemistry teacher."

Mrs. Ovchinnikova descends from one of the numerous nomad tribes that roamed Siberia before the tsarist Russians conquered the land and that gave the city of Yakutsk and the Yakutsk A.S.S.R. their names. Her handsome features are somewhat Mongoloid.

Tradition hints that the Yakuts came from the southwest; they are physically Mongoloid, and speak a language related to Turkish.



Gingerbread eaves and pedimented windows decorate a weathered house of squared logs in Irkutsk. Though scorned as old-fashioned by progress-conscious Russians, such durable and handsome buildings survive from Leningrad to Vladivostok.

Fur-hatted stewardess named Tamara settles her passengers in an airplane cabin whose ice-covered ribs reminded the author of "a refrigerator in need of defrosting." Passengers remained bundled throughout the flight.

Fluffy snowsuit prepares a tyke for frigid Oymyakon's outdoors. His one-piece garment traps a layer of insulating air.

REDACTION (LOWER) AND EXTREMES BY DEAN CONGER © N.C.C.



The tsars made no effort to kill off Siberia's aboriginal tribes. They merely exploited them.

In recent decades the government has tried to bring the Yakuts and their fellow tribesmen into the mainstream of Soviet life, while working at the same time to preserve their languages. Soviet scholars have even devised alphabets for tribal languages and have put down tribal traditions in writing. Some schools teach Yakut, but Russian is used in the higher grades because more textbooks are available in that language.

Siberia Respects Its Nomadic Heritage

"We are trying to preserve the nomadic culture," said Mrs. Ovchinnikova. "Reindeer must still be herded by nomads, and there are many herds in our republic. The parts of the native costume that are useful are also being saved. Native reindeer-skin boots and parkas are used everywhere in this region because they are practical.

"But our most important work is directed toward the future. We have in mind a





314



Tending a fiery "potline," a worker stirs a stew of alumina to keep a crust from forming. In this giant plant near Irkutsk, seemingly endless rows of electrolytic furnaces, or pots, glow at nearly 1,800° F. to smelt pure aluminum from refined ore.

Around the necks of two workers hang breathing masks that strain out carbon particles (below). One man powders his face to protect the skin.

RODACHROME (BELOW) AND FETACHROME © N.S.S.



tremendous hydroelectric development on the Lena. Our scientists say the huge reservoirs created for that purpose may even affect the local climate.

"Work has also begun on the covered city of Aykhal, a series of interconnected buildings that will enable everyone to stay indoors all winter."

That evening I had my first meal in the true northern-Siberian style. Horsemeat (considered a delicacy), braised arctic hare, potatoes—even cranberries, which had been kept fresh-frozen in a hole in the permafrost. *Spirit*—spirits—a drink that is 96 percent alcohol, was also served. This potent beverage, which doesn't freeze as easily as vodka, is a basic element of Siberian hospitality.

As the waiter poured my drink, he asked Ruzhnikov, "Does the American need water in his spirits?"

"But of course," said my considerate guide, "or he'll be in flames."

We went to bed early that night since we had to rise at three in the morning to catch a plane to the *real* north. Though we arrived at the airport at four in the morning, we couldn't take off until noon because of "human-habitation fog."

When we finally boarded the airplane, the metal fittings inside the cabin were as icy as the inside of a refrigerator in need of defrosting. But my gloom was dispelled by our comely stewardess, Tamara Druzhi-nina, a Siberian fashion plate in green tights, fur boots, a blue coat, and a striking white fur hat (page 313). Gold-capped front teeth were the only flaw in Tama-ra's beauty. Though dental work is free in the Soviet Union, people have to pay for their own caps, and ready-made gold ones cost less than porcelain.

Warm Welcome to the "Pole of Cold"

The flight took us over low mountains and hills and forested valleys, all part of the monotonous *taiga*, boggy woodland, covering the heart of Siberia. At last, at three in the afternoon, just as the setting sun spread a warm glow across the cold land, we came down at Oymyakon, the coldest town in the world.

Home of 3,500 people, Oymyakon exists primarily to support an immense animal farm. It is the only community in the world where a temperature of -96° F. has been recorded. Few Western correspondents have ever penetrated the *taiga* to this remote outpost. I asked to go there to experience the ultimate in Siberia's spectacular weather (pages 298-9 and 306-7).

The airport manager ran out to the plane even before we disembarked and reported that it was only 40 degrees below zero. "But, anyhow, welcome to the 'Pole of Cold,'" he said with a flourish. "I hope you find your reception warm."

After we deposited our luggage in a barracks set aside for weathered-in pilots and visiting officials, we had tea, Russian style, in a glass with a metal holder.

"Hottest tea of the U.S.S.R. in the coldest place," the manager boasted.

Deepest lake in the world, Baykal pours an ice-free stream into its only outlet, the Angara River (right). The sparkling view has attracted two guests from a nearby health resort. Before the last link in the Trans-Siberian Railroad skirted the precipitous shore, trains in winter dashed across Baykal's paving of ice—which bridges waters a mile in depth. Ferries carried them in summer.

In modest embrace, a couple dances at the clubhouse of a lumberjacks' village near Lake Baykal.



Then a jeep took us to the warm office of the director of the animal farm, a stocky, round-faced Yakut. As a sure conversation starter, I asked him how cold it had to be before they closed the schools.

"It doesn't matter how cold it gets," he answered. "If we were to mind the mercury, schools would be closed half the winter."

Then he went on to explain the farm's operation. "Oymyakon is basically a breeding station for reindeer, horses, a few cows, and silver foxes [page 308]. We butcher the reindeer and

horses for their meat, and feed the scraps to the foxes. We also have hunters and trappers working for us in the taiga."

I asked if I could visit the reindeer herds and the trappers.

"They have been in the taiga for more than six weeks," said the director, "and we don't know where they are. It's about seventy miles to the nearest reindeer herd, and the only way to get there would be by helicopter."

To my knowledge no Western correspondent had ever rented a helicopter in the Soviet



EDRACHROMES © NATIONAL GEOGRAPHIC SOCIETY

Union. "Could you get me one?" I inquired.

"I don't know. It has to come from Khandyga—225 miles away. I'll see what I can do."

A telegram went off to Aeroflot, which does all nonmilitary flying in the Soviet Union. In several hours we had our reply: "Helicopter will be in Oymyakon tomorrow morning. User will pay by the hour."

I could hardly believe it. It was too easy.

Sure enough, the next morning the helicopter arrived, and with the director standing between the two pilots, pointing the way, we

were off. We flew up one valley and down another, skimming over magnificent ridges topped with frost-covered evergreens. The country reminded me of northern Minnesota.

After an hour I began to get a little uneasy. On the frozen lakes and rivers there were many tracks that could only have been made by a large herd, but no reindeer appeared.

By 2:30 in the afternoon the sun was nearly down. We gave up the search and landed again at Oymyakon. I stepped out into a crowd of about a hundred children who had come to



SAFARI (BELOW) AND HUNTING © R. S. L.





Frozen in motion, silhouetted boys zip over Lake Baykal's glinting face. They chase a spherical, rather than a flat, hockey puck across a rink that appears narrow in this telephoto-lens view. Often, lone skaters dart miles from shore, skipping from one snow-free patch of ice to the next. A cloud bank looms over the mountains that cup Baykal's 420-mile length and 46-mile breadth.

Picnicking on a mirror of ice, lumber-camp officials treat themselves to an outing on Baykal at day's end. Slated to become the Soviet Union's first national park, the lake and its shores harbor about 1,000 species of animals and plants found nowhere else—including a fresh-water seal. But conservation-minded Siberians fear wastes of paper plants will pollute waters now so clear that bottom can be seen 100 feet down.

see the helicopter and the American (page 304). The village chairman, Yegor Keremyasov, invited us to eat. Wending our way from the helicopter to the *stolovaya*—the restaurant—I felt like the Pied Piper of the Pole of Cold. All the children were right behind me.

I hadn't expected gourmet food in Siberia, and I found none. But I did find substantial, filling, and tasty fare. On this occasion the meal consisted of roast ribs of young horse, rice, gravy, and beef tongue. It was delicious.

Raw Fish Served With Frozen Cream

Later that night I was invited to the home of Maria Krivoshapkina, a milkmaid who also sews boots out of reindeer hide. Her house was the traditional log building, but plastered both inside and out against the wind. She offered us an unusual meal: *stroganina*—raw frozen fish—braised reindeer, and *chokhon*, a cheeselike frozen cream. With spirits, of course.

Stroganina once was considered a health food. Its preparation was simple: The cook smashed a frozen fish into pieces and served it. Today, eaten as a delicacy, it is offered in thin, tooth-cracking strips, seasoned with red pepper, salt, and mustard. Eating stroganina is like swallowing fish-flavored ice that turns into a raw oyster on its way down.

During the dinner I picked up odd bits of information about local food and drink. Frozen blocks of milk are transported in baskets during the winter. Old Yakuts like to eat frozen marrow from reindeer bones. In summer, a refreshing, nutritious, and slightly intoxicating beverage called *kumiss* is brewed from mare's milk and drunk in great quantities from large wooden goblets called *chorons* (page 334).

Oymyakon did finally produce a reading of -69° F., a fact that I verified with my own thermometer. But, fascinating as the visit had been, I was not reluctant to leave for the 10-below-zero comfort of Irkutsk.

Wherever I wanted to go in Siberia, it appeared, I had to leave from Irkutsk to get there. I went through the city eight times.

In this busy "Chicago" of Siberia, more than 400,000 residents enjoy a lively cultural life, with a concert hall, a circus, and theaters. Irkutsk prides itself on a university, several technical institutes, and modern factories. Neon signs flash along its streets, most of which are paved.

One night Ruzhnikov and I went to see a traveling comedy troupe from Moscow. The hall was jammed with students and workers. I needed no Russian to understand the spoof on red tape, a skit that had the audience



shaking with laughter as a pompous bureaucrat kept pulling out his rubber stamp, blowing on it with a loud "Whoo!" and slamming it down on a sheet of paper. I laughed helplessly as I thought of my own experiences with some Russian officials.

Public Water Taps Serve Many

In contrast to all the modern aspects of Irkutsk, a community water tap gurgles just two blocks from the city square and the modern government buildings. The sheltered faucet, one of many in town, draws an endless procession of women, who fill metal buckets and carry them home on the ends of poles balanced on their shoulders.

A number of Irkutsk's handsome old wooden buildings were still in use, but some resi-

dents objected when I photographed them. They wanted me to take pictures of the monotonous rows of prefabricated concrete apartments growing up all over the city. "The old things are dead to us," they told me.

Today's modern town began in 1652 as a winter outpost for the collection of tribute, payable in furs, which the tribes were forced to deliver to agents of the tsars. This tax had been levied on the indigenous Siberians ever since Cossack troops led by Yermak Timofeyevich defeated the Tatar ruler of Siberia in 1582, opening Siberia for expansion of the Russian Empire.

Nomadic tribesmen in the area of the outpost—the Buryats—lived in felt-covered tents, called *yurts*, on the shores of Lake Baykal. The conquering Cossacks, adventurers who



PHOTOGRAPHS BY DEAN CONNER © N.S.S.

Concentrating on their game, boys ignore summertime clouds over Bratsk. They risk getting drenched in a rainy season that produces, in this area, some 15 inches of precipitation. Their homemade, blanket-topped pool table stands outside apartments built a decade ago for workers who raised a mammoth dam across the Angara River (page 340).

Lady lumberjacks guide winter's stockpile of logs into a sorting channel. Only during the summer thaw can this camp's harvest of larch, pine, and fir be chained in rafts and towed away on Lake Baykal. Most logs go to builders and paper mills in the region, but some reach customers as far away as Japan. These Buryat women, descendants of nomadic tribespeople, help the U.S.S.R. exploit timber resources greater than any other nation's—chiefly virgin stands in the Siberian taiga, a belt of coniferous forest 1,000 miles wide and more than 3,000 miles long.



often lived outside the law, were great fighters, loyal to the tsar. For their fort the Cossacks chose a place on the broad Angara River 47 miles from its source in Lake Baykal. Fed by the great lake, the swift-flowing river never freezes over here nor does it vary in volume.

Fresh-water Seals in a Mile-deep Lake

In summer the Angara served as an excellent highway for transport of pelts northward and supplies southward to the city. Irkutsk became a key station on the Trans-Siberian Railroad, and the last major stop in the U.S.S.R. on the way to strategic Mongolia.*

One day Ruzhnikov and I drove the short distance to Lake Baykal, the world's only mile-deep lake. Stretching 420 miles long, and up to 46 miles wide, it contains nearly as much fresh water as all the Great Lakes combined—water pure as rain and so clear that one can see bottom 100 feet down. More than 300 rivers and streams flow into Baykal, but only the Angara flows out (pages 316-17).

In and around the lake live about a thousand species of plants and animals found nowhere else in the world. Among them: a fresh-water seal, *Phoca baicalensis*, and a delicious

Day of adventure: Nursery-school children in Maloye Goloustnoye set out on a nature hike to the forest where their parents labor. All live in log houses like those they pass. Each family fences in its quarter-acre yard to keep a cow, hogs, or chickens. Daily bus service links the community with Irkutsk, 60 miles away.

Devoted to family, timber cutter Aleksandr Moskovskikh, an ardent angler, teaches his son to tie flies. His daughter serenades him with her accordion (above, right).

With a chain saw, Mr. Moskovskikh fells about 900 trees during a 41-hour, six-day week. He spends only six dollars of his \$150 monthly wage for rent, fuel, and electricity.

*See "Journey to Outer Mongolia," by William O. Douglas, NATIONAL GEOGRAPHIC, March, 1962.



RODOLPHOES © NATIONAL GEOGRAPHIC SOCIETY





Like homesteaders of the American West, axmen hand-hew dwellings at Verkhoyansk—a settlement north of the Arctic Circle for trappers and drovers of cattle, horses, and reindeer. These men cut mortises for roof timbers of an apartment building. Before the brief summer ends, they will chink gaps between the roughly squared logs and, this far north, plaster the walls outside as well as inside. A layer of dirt or moss above the ceiling will add more insulation.

Proud builder, a man stands outside a nearly finished house he has erected for his daughter at Bratsk (above, right). The government owns most of the housing in the Soviet Union, but it encourages private home building to relieve the shortage in this rapidly developing area. Although apartments provide central heating and indoor plumbing, one family in ten accepts land, materials, and tools to build homes that often lack these amenities.

Telltale rows of trees trace the meandering of the Yana River near Verkhoyansk. Established conifers seed furrowed ridges of silt that the Yana deposits with each flood in ever-shifting oxbows.



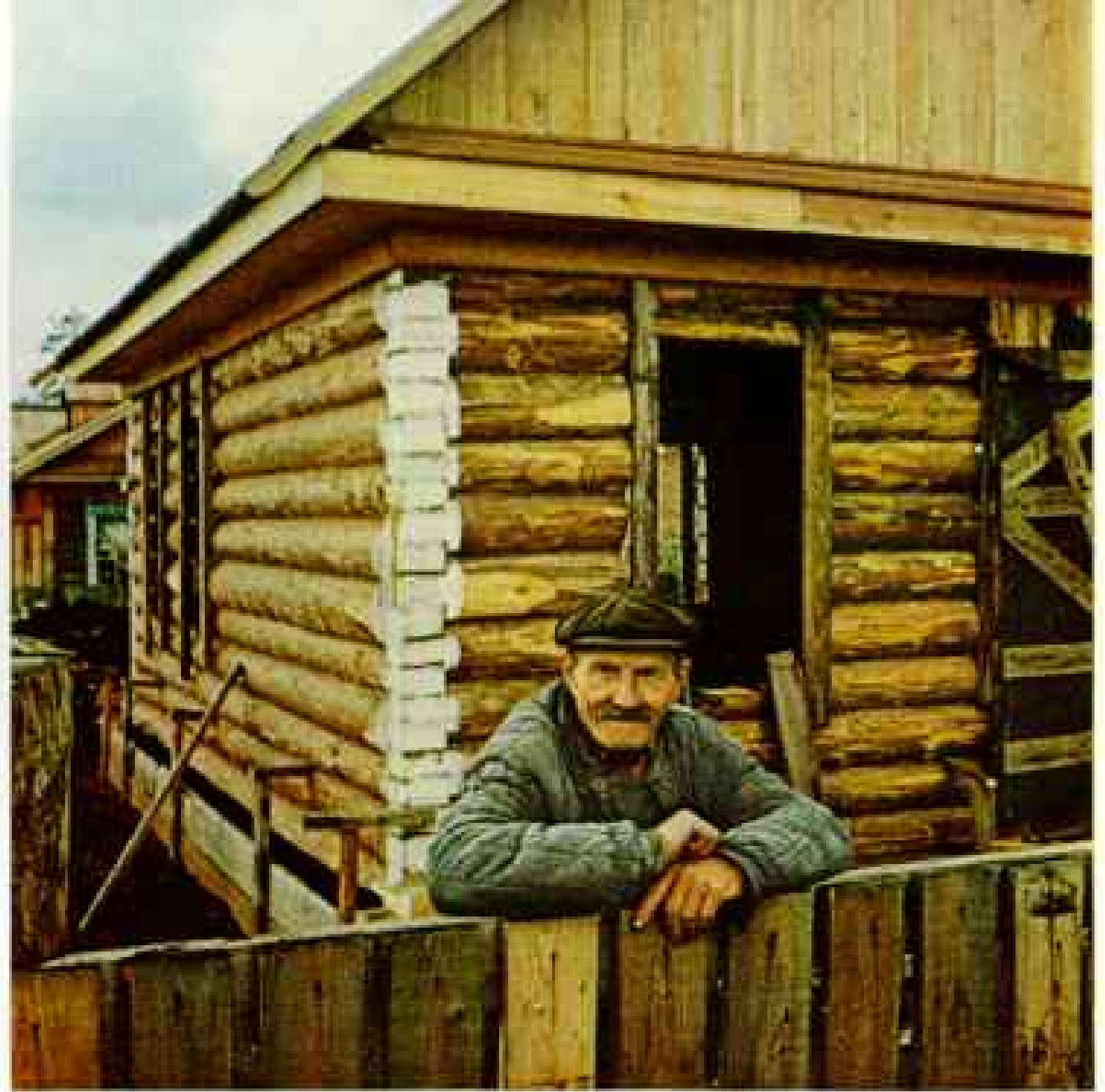

EPICHOME (BELOW) BY STEE WOODS, WOODS PRESS AGENCY; EPICHOME (ABOVE, RIGHT) AND KOSACHOWE BY JEAN LORSEN © N.S.S.



and abundant sculpinlike fish, *Comephorus baicalensis*, that lives at half-mile depths.

The lake had frozen solid to a depth of five feet, but the Angara, clear of ice, flowed on. Going down to the river, we watched as ducks flew up to the edge of the ice and then floated back downstream in the fast current.

Out on the ice, against a backdrop of snow-covered mountains, a group of young boys played vigorous hockey (page 318). Lone skaters darted along, miles out, jumping from one snow-free spot to another. Between drifts the ice glistened, so pure it looked like plate glass. It was no surprise to learn that this unique and beautiful area may become the Soviet Union's first national park.

Winter Stay Ends With a Picnic on Ice

On our last winter day in Siberia, Ruzhnikov and I returned to the lake to visit a timber-shipping camp along the shore. As the sun went down in a pink-and-blue evening, the timbermen took me out on the ice for a picnic. Fish and boiled eggs were set out on the slick surface, and we drank numerous toasts in "Baykal water"—vodka, of course. I was urged to return in summer, and by now I realized that another trip in the opposite season would be necessary if I were to present a balanced picture of this land of extremes.

In Moscow the following June I asked for official permission to visit Tiksi, near the delta where the Lena River enters the Arctic Ocean, and to take a ship from there during the few months when the "Northeast Passage"—the route that links European Russia and Siberia's scattered ports—is ice-free and navigable. Permission was refused. Most requests to travel in remote areas of Siberia are turned down as a matter of course, and have been for years. For this reason Siberia, for foreigners, has always been a land of rumors and secrets.

To many Westerners, Siberia even today is a sinister place of bitter cold, full of political exiles. Under Stalin it acquired the reputation of being one vast forced-labor camp. It was so effectively sealed off from foreigners that anything said about it might, for all they

Girls pay homage to the past in the walled Square of the Heroes of the Revolution at Novosibirsk—largest Soviet city east of the Urals. The metropolis of more than a million people mushroomed during World War II, when factories in European Russia were relocated here, beyond reach of invading armies.





knew, have been true. Few journalists from the West ever got there to set the facts straight; few get there today.

By now I knew a bit about the country and understood better why exploring it was so difficult. Secrecy is not, I think, the only reason for travel restrictions. While there may be prison camps and space installations and test sites for atomic weapons, it would be easy to keep curious eyes away from these places.

I think the reason that tourists today are allowed to visit only a few places in Siberia is that Russians are a proud people. Tourist facilities in the hinterland are almost nonexistent. The Soviets don't want anyone, particularly Americans, to see anything substandard in their country.

In Siberia in Summer, Day May Last All Night

Fortunately I was able to revisit Yakutsk in summer and to look in on three other remote communities, including Verkhoyansk—another animal farm, farther north but not as cold as Oymyakon. Yevgeniy Ruzhnikov came along again as guide and interpreter.

After the inevitable stop at Irkutsk, and another at Yakutsk, we crossed the broad Lena River, now full of barges and ships taking advantage of its short open season. Four hundred miles farther north we touched down at Verkhoyansk (map, pages 304-5).

Wrapped in an old skirt of wooden houses, Yakutsk cloaks its heart with pastel-hued modernity. Engineers from this capital of the Yakutsk Autonomous Soviet Socialist Republic hope to build cities with interconnected buildings whose residents need never be exposed to winter's bite.

Madame President, proud mother: Mrs. Aleksandra Ovchinnikova beams as she tells of her son's graduation as a civil engineer. Chief executive of 650,000 people, she presides over a region more than four times the size of Texas—the 1,210,000-square-mile Yakutsk A.S.S.R., largest of the Soviet Union's autonomous ethnic republics.



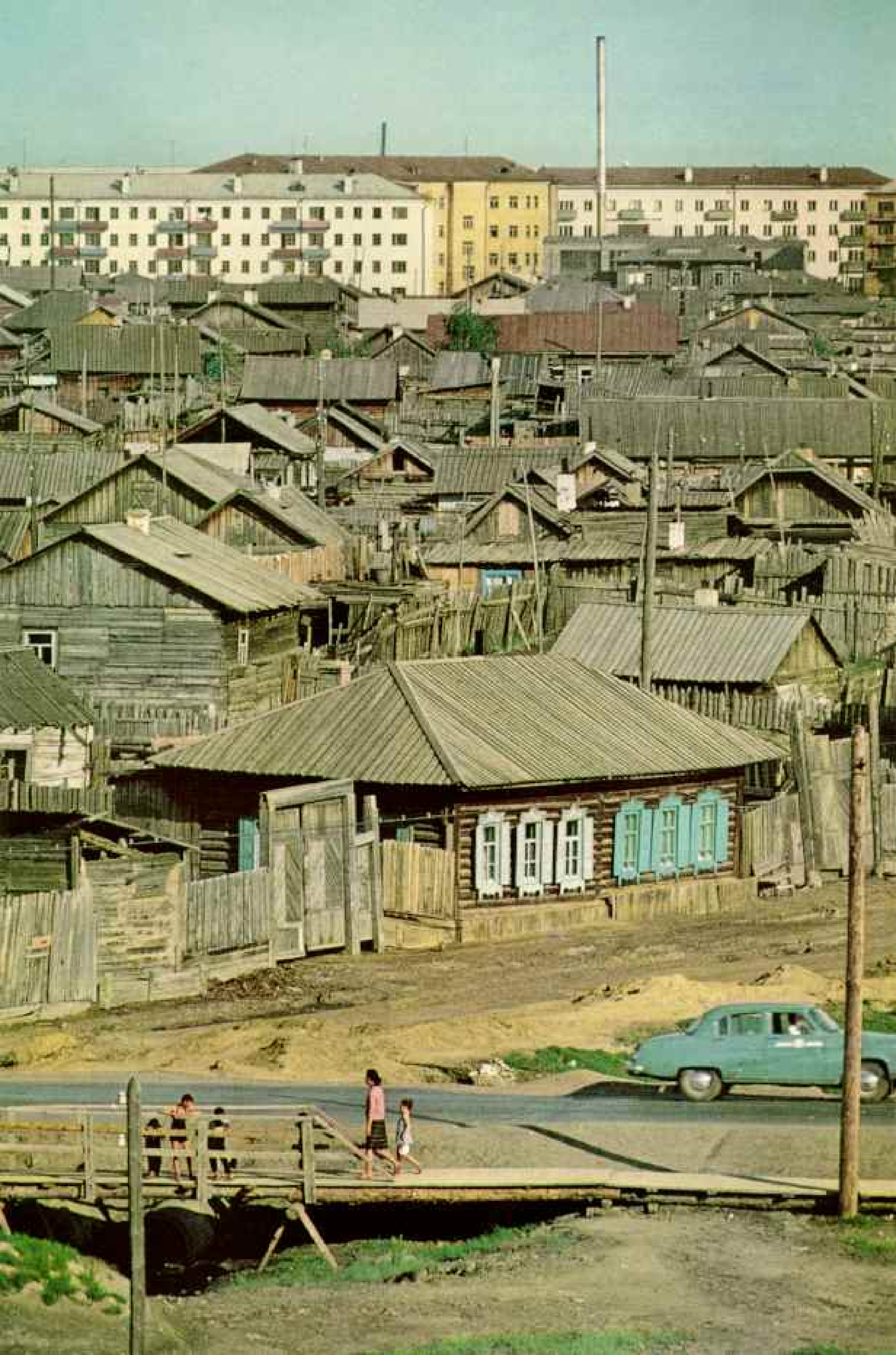

Cossack explorers founded this remote settlement in 1638 as a place to shelter themselves during the winter. Today, like Oymyakon, it lives by horse, cattle, and fox farming and by the breeding of half-wild reindeer.

Strangers find Verkhoyansk a disorienting place. In June the sun does not disappear behind the mountains until 11:30 at night and reappears at 1 a.m. We went to a movie, which ended at 10:30 p.m., and came out with the crowd into bright sunlight.

Settlers from more southern latitudes find it difficult to get used to these nightless summers and dayless winters. The government even conducts research to find out how the strange seasons affect the human body. My own observation is that people figuratively hibernate in winter (the streets are empty at 6 p.m.) and live fully, almost without sleep, during the summer nights.

To me, the Soviet attitude toward the time of day was a disturbing element. Like most provincial Soviet towns, Verkhoyansk has radio loudspeakers set around the central area, blaring local programs or broadcasts from Radio Moscow at all hours. I found it troubling to hear a voice shout "good morning" at two in the afternoon. Many clocks and most travel schedules keep Moscow time, seven zones away.

Capitalist Food for Communist Mosquitoes

One hot day the village music teacher asked if we would like to go swimming. "Isn't the water too cold?" I asked.

"Oh, the river is too cold, but there is a very pleasant lake near the airport."

The temperature had climbed above 90°, high enough to warrant a swim north of the Arctic Circle. I wore side-lacing Russian bikini-style trunks, but the crowd at the beach quickly spotted me as a stranger because of my six-foot-two-inch height and my cameras.

Later, as I sat in the sun with my friends, horseflies and persistent mosquitoes from the bogs of the taiga began to bother us. I had some insect repellent in my camera bag and began to spray myself with the aerosol can. Everyone was fascinated. But soon I began to draw more mosquitoes than anyone else.

"Your capitalist repellent," they told me triumphantly, "is merely food for our Siberian mosquitoes!"

At the end of the three days allotted me in Verkhoyansk, Ruzhnikov and I boarded an elderly aircraft containing an assortment of herdsmen and scientists, supplies and instruments, and headed southwest across the meandering Yana River (pages 324-5.)

At Yakutsk, in the same hotel where I had





Reveling in the blaze of summer, merry-makers go ashore from a Sunday excursion cruise to toss a beachball. Sun-starved Siberians make the most of the few weeks a year when bikinis are more practical than furs.

Aboard the ship, a social director teaches a young passenger the twist (right). The vessel sandwiches excursions between workaday runs on the Lena River, Siberia's longest at 2,680 miles. The craft belongs to a fleet that supplies river cities from the Arctic port of Tiksi during the ice-free months.

Yesterday's news shades the face of a teen-ager bronzing by the Amur River at Khabarovsk, a Far Eastern city only 35 miles from the Chinese border.

PHOTOGRAPHS BY DEAN COHLEN © N.A.S.



spent my first Siberian winter night, I was kept awake until after midnight by singers who held forth under the windows. Dozing at last, I was awakened at 4 a.m. by the hot sun streaming into the room.

Treeless Yakutsk in summer becomes a vista of dust and mud, with building cranes and new construction everywhere. I found a pleasant contrast to the dreary, bustling scene in the house of Semen Pesterov, a sculptor whose medium is the ivory of mammoths

which became extinct some 10,000 years ago. His carvings, in classic Yakut style, represent reindeer and other animals native to the region (page 301).

Yakuts Dance Around Tethered Horse

A Yakutsk official invited us to a summer festival—the national holiday called Vsyakh—based on ancient tradition (below and two following pages). We traveled to the collective farm of Tyungyulyu, two hours upstream

332



from the city by boat and two more cross-country by jeep.

Hundreds of people had gathered in the village. Ceremonies began with speeches. Then, official business concluded, the picnic began—a feast of boiled beef and kumiss.

Next came a “Hitching Post” dance. Men and women formed a circle around a tethered horse and chanted a song that had only two notes. It sounded like a yodel. I was told that the improvised words always celebrated the

Adding a new touch to tradition, a collective farm at Tyungyulyu opens *Ysyakh*, a Yakut national festival. After officials present annual reports and give awards to outstanding workers, the farm’s 550 families and their guests celebrate summer’s arrival with food and fun in the manner of their nomad ancestors (next pages). Members of the collective farm breed horses and foxes, tend thousands of beef and dairy cattle, and grow grain to feed the livestock.





Bolting from handlers, an eager horse leaves competitors at the starting post in a race run at 11:30 p.m. As the climax to Tyungyulyu's Ysyakh, the collective's six villages match prize steeds under the midnight sun until 2 a.m.

At a collective cookout, workers dine on boiled beef and *kumis*—fermented mare's milk. Yakuts drink their favorite brew from *chorous*, king-size, carved wooden goblets like the one on the ground at center. Later, the men will join women to dance around a tethered horse, while singing songs of joy and thanksgiving in their national tongue, a language related to that of the Turks.



joy of living and the pleasure of meeting friends, and gave thanks for good health. None of the dancers could account for the horse. The explanation must lie deep in a past that predates Yakut written history. The festival continued with more dancing, some foot races, and, well on toward midnight, a horse race.

One Sunday morning Ruzhnikov arranged an outing from Yakutsk aboard a vessel on the Lena River. All Siberia seemed sunny and warm when we boarded the *Mekhanik Kulibin*. As we pulled away from the dock, a youthful seven-piece orchestra played modern Russian music, generally off key.

With Ruzhnikov as interpreter, I got into a conversation with an automobile mechanic named Aleksandr. While we picnicked aboard, Aleksandr told me tales about bears. Bear stories, I discovered, are almost as much a part of Siberian conversation as talk about the weather.

Bad Luck to Harm a "Little Mike"

Bears seem of great sentimental concern to Russians, who invariably name them *Myshka*, or "Little Mike." Aleksandr told me that Yakuts will not kill a bear unless absolutely necessary. If they do, they believe, something bad is likely to happen.

He knew of a man who shot a bear as it slept harmlessly on a floating piece of ice. Shortly thereafter, the man's son drowned close by.

I had decided that, after Yakutsk, I would go back to Khabarovsk, an industrial city of 402,000 people at the confluence of the Amur and Ussuri Rivers, only 35 miles from the Chinese border. I had been there once before with my wife Lee, but as tourists we had seen little of that Far Eastern city. We had traveled there on the famous Trans-Siberian Railroad, coming in from the eastern seaport of Nakhodka (following pages), where we had first set foot on Siberian soil.

The Trans-Siberian, longest railroad in the world and a historic engineering achievement, was begun in 1891 and completed 12 years later—except for a section around Lake Baykal. At first only a single track, laid in a hurry, it required constant repair. During the winter, the tracks ran over Baykal's thick covering of ice; in summer, trains crossed the lake on ferries. This slender thread soon helped transform Siberia.

It had been summer when I traveled the strategic line with Lee, and the hills and fields, the numerous small farms, looked lush and green as they streamed past our windows in an unchanging panorama.



In the Russian manner, we had shared our compartment for four with strangers. Our companions had been agreeable, however, and the bunks quite comfortable. In addition to de luxe accommodations like ours, the train offered a second class, with slightly harder bunks, and a third class in which the entire car was open and became, in effect, a dormitory.

I made several friends by taking their pictures with my Polaroid camera and giving them prints. In the dining car, which had excellent food, a group of Russian servicemen became so friendly that I had trouble getting away from the typical vodka hospitality.

Tigers Roam Where Reindeer Graze

Returning to Khabarovsk now as a reporter, I had to go thousands of miles out of the way and approach by jet plane—from Irkutsk, of course. Ruzhnikov and I made our first call on the director of the natural history museum, Vsevolod Sysoyev, a delightful, elflike man with pepper-and-salt beard.

“The interesting thing here,” he said, “is the existence, among our far-northern species, of plants and animals that people think of as being almost tropical. Lush vines wrap our birches, and tigers live in the same forests as reindeer.

“The summer is warm and humid, as in the northern jungles of the Himalayas. But winter is severe; a cold, dry wind

From village to city in 17 years, Nakhodka grows beside a sheltered bay kept open by ice-breakers during winter months. Mechanized wharves handle cargo swiftly at this bustling commercial port. Vladivostok, huge naval base and Russia's traditional outlet to the Pacific, lies 50 miles to the west.

Clublike informality makes friends of strangers sharing a compartment on the Trans-Siberian Railroad. The women play cards in a “hard-class” car. Firmer pallets set it apart from “soft,” or first-class, accommodations. Third-class travelers use an open dormitory car. Baggage regulations allow “one bird in a cage” at no extra cost. The nearly 6,000-mile trip from Moscow to the Pacific takes seven and a half days.



blows in from the north. In the Amur River, near here, you can catch beluga, the biggest fresh-water fish in the world. They sometimes reach a length of 15 feet, and one has been known to yield two barrels of black caviar."

The director closed our interview by quoting a statement made by Prince Alexander Nevski as this medieval Russian hero and saint set free German knights taken prisoner after they had invaded Russia.

"Go now," he is supposed to have said, "and tell everybody to come to our country as guests without any fear. But he who comes with a sword will perish of a sword."

My host concluded, "I hope this helps you grasp the Russian nature. We are two big countries, your nation and mine. If we do not keep the peace, our descendants will curse us."

Gratitude Undimmed by Two Decades

To see something of the impact of the modern world on Khabarovsk, I visited a furniture factory. All designs executed here, its chief engineer explained, were received from a bureau in Moscow. As he showed me through the place, a rosy-cheeked woman rushed up to me in tears (right).

Ruzhnikov translated as she spoke rapidly in Russian: "Please excuse me," she said. "I heard there was an American in the factory and I just want to express my thankfulness to the American troops who liberated me from Germany in 1945."

Not knowing what to say, I asked her for the details.

"I was 22 at the time," she told me. "I couldn't walk and weighed only 80 pounds. Your soldiers rescued me from a burning barracks at a forced-labor camp in Germany. My name is Olga. Please pass on my best regards to the former soldiers who liberated me and gave me such good care for the six months I was in a hospital."

Later on that same hot July day, I joined swimmers at the edge of the slow-flowing Amur River. The place was crowded. Siberians all seem to be great swimmers and sun worshipers, perhaps because their summer season is so short. I carried a small waterproof camera around my neck and swam out among the people. Bathers eyed me curiously as I ducked in and out of the water.

I returned to the shore near a group of very pretty girls who were pushing each other into the river. Suddenly I found myself surrounded by the giggling group. With a chanted count

of "*raz, dva, tri*," I, too, was sent splashing.

I had an invitation to return to the timber camp beside Lake Baykal where I had concluded my winter visit. A jet plane and a new hydrofoil speedboat got me there swiftly and comfortably.

It was a beautiful afternoon. Clear, almost glassy water reflected the rugged shoreline. I remarked on its serenity.

"Don't let it fool you," said the hydrofoil skipper. "Storms come up very quickly on

"Your soldiers rescued me," a woman named Olga recalls emotionally on meeting the author. Tears of joy streaking her face, she dashed up while Mr. Conger toured a Khabarovsk furniture factory and requested that he express her thankfulness "to the American troops who liberated me from Germany in 1945."

GI's freed Olga from a labor camp. A six-month stay in a U. S. Army hospital restored her to health before her return to the Soviet Union.



Baykal. In fact, we don't call it a lake but a sea. Sometimes, we think it's an ocean."

The next morning we toured the lumbermen's village. It consisted of new individual homes, neatly fenced, with a huge stack of split firewood beside each. Children of the nursery school walked down Peace Street on their way to a nature hike (page 322). A motorcycle left a cloud of dust on Baykal Avenue, and a horse-drawn wagon turned into Tschai-kovsky Street. We drove on to the forest.

There we stopped to watch Aleksandr Moskovskikh, a wiry lumberjack, cutting trees with his chain saw. I asked how many days he worked.

"Seven hours a day for five days and six hours on Saturday," he said. "On the seventh day I'm a devoted fisherman. I make my own

flies. I go along the river and watch nature, seeing what the fish snap at. Then I tie a fly on the spot. Why don't you come to my home tonight, and I'll show you how I tie them?"

That evening we joined Moskovskikh, his wife, and two children, for a delicious fish-pie dinner, and I learned something about how they live (page 323). For their modest log home they pay six dollars a month—for rent, firewood, utilities, and maintenance. Their toilet and fresh water are outside.



STACHTHIRE © R.S.A.

The house was built on about a quarter acre, giving them room for a cow, a few hogs, and some chickens. The family salts the fish they catch and stores the wild mushrooms and cranberries they pick in the taiga. They hold a plot in the community garden and grow potatoes on it.

The son studies history, English, literature, and physics. The girl, fond of music, practices the accordion after school. Mrs. Moskovskikh makes clothing for the children. They have a bicycle and a motorbike for getting around in the village.

A daily bus service links the timber camp with Irkutsk, but the Moskovskikhs prefer to spend their free time in the forest. They go to the city only two or three times a year. They do, however, go to the village club in

the wintertime to dance and see the movies.

I asked Moskovskikh why he had come to Siberia. "I was born here," he explained. "But you, too, seem fond of Siberia."

"I've met fine people here," I replied.

"And that is another answer to your question. That is why we stay in Siberia. And if you like hunting and fishing as much as I do, this place is as close to heaven as you are likely to get. I'm proud to be a Siberian."

On the boat back to Irkutsk next day I heard of a disturbing development that may affect Lake Baykal. The crystal lake is in great danger of being polluted. Two large pulp and paper plants, now under construction, propose to dump their noxious wastes into it. A controversy was raging; many people demanded that the wastes be diverted to the Angara River. Conservationists and economic planners argued bitterly. So far, the question is unresolved.

Three hundred miles northwest of Irkutsk lies the brand-new town of Bratsk, grown up on the Angara River around the world's largest hydroelectric plant (next pages). We flew there through rain and fog and were met by a guide who spoke excellent English and had a head full of facts.

"The dam can generate twice the electricity of your Grand Coulee," he informed us. "There are 140,000 people now in the Bratsk area, and the average age of adults is under 30. Building was difficult here because the ground is frozen six months of the year. People at first lived in tents. There was a terrible mosquito problem until the dam was completed and the lake began to form, covering the insects' swampy breeding grounds."

I found myself liking Bratsk. I could see and sense its pioneering spirit. New flats and stores were rising out of seas of mud. In one area I saw thirty apartment buildings in various stages of construction. In another were a number of log and wooden homes, many built by the owners themselves (page 325).

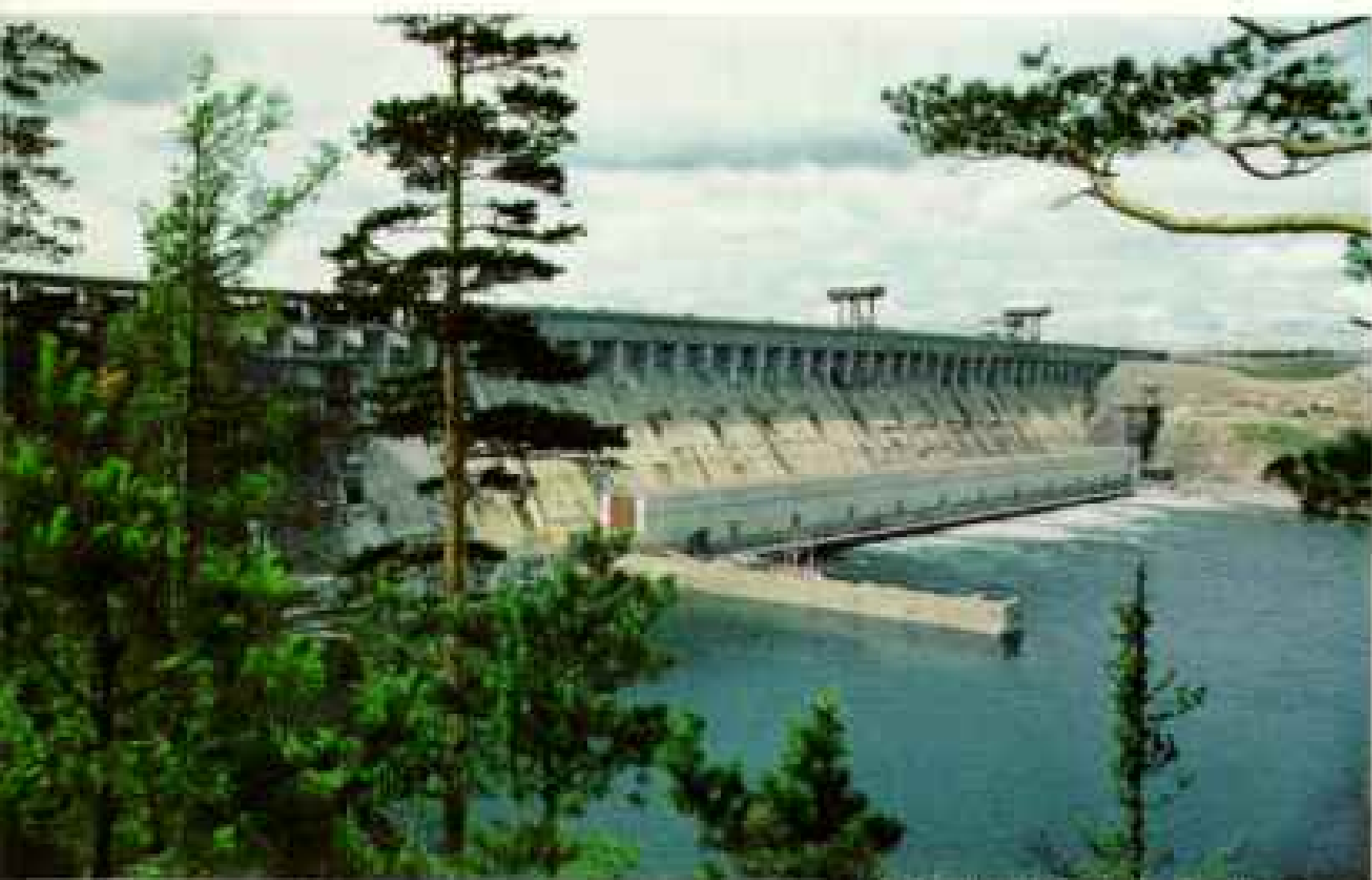

BRATSK DAM, SIBERIA, U.S.S.R.

Harnessing the Angara, the world's largest hydroelectric project powers a growing industrial complex in a former wilderness. The Bratsk Dam (left) flings earthen arms from its 4,900-foot concrete center for a total span of more than three miles.

Chief Engineer Ivan Glukhov (right) will add three more units to the 17 that hum in the station's turbine room (below). When construction—under way for 12 years—ends, Bratsk will boast a capacity of $4\frac{1}{2}$ million kilowatts. Plans call for the building of four more dams downstream on the Angara.





These had no running water or sewer system and depended on wood for heat.

"Personally," the guide said, "I prefer an apartment where I have to pay only 5 percent of my salary—for everything."

Bratsk, like other isolated frontier areas in Siberia, he said, offers high salaries to workers who will come and stay—initially 40 percent more than the basic Soviet wage and ultimately as much as 50 percent.

The Angara sends a uniform, year-round flow into the dam. To take advantage of this assured volume of water, four more dams are planned farther downstream. The Russians claim that when these are completed, the river will produce one-third as much hydroelectric power as all the present installations in the United States.

In its first application, the dam powered an aluminum plant. Now a large wood-products plant is in production. Since 1955, Bratsk has progressed from outpost to thriving factory center.

Science Town Plans Russia's Tomorrow

If Bratsk symbolizes Siberia's leap into the future, Novosibirsk, Russia's largest city east of the Urals, may be called the place where the future has already arrived. We went to this last stop of my Siberian tour by train, an express that would roll on to Moscow.

Novosibirsk was founded where the Trans-Siberian tracks bridge the Ob' River. Many factories moved there for safety during World War II, and the town boomed to a population of 800,000. Now 1,029,000 live here. But the jewel of Novosibirsk actually lies 25 miles out of town on the shores of a reservoir called the Ob' Sea. This is Akademgorodok, generally referred to in English as Science Town. It looks nothing at all like other communities in Siberia.

Andrei Trofimuk, deputy director of the entire development, talked to us:

"This city was only an idea on paper in 1957," he said. "Now we have the Siberian Department of the Academy of Sciences and twenty separate scientific establishments concerned with nuclear physics, chemistry, biology, geology, and economics. The city resulted from the need to realize the potential of Siberia—its rivers, forests, and the resources under the ground."

I toured the nuclear physics laboratories with one of the chief scientists, a humorous, soft-spoken man who talked with enthusiasm of his early years with Igor Kurchatov, who helped develop the Soviet nuclear bomb.

"I consider nuclear physics the greatest achievement of contemporary science," he told me. "It is the duty of men to use this knowledge for peace."





Brand-new Bratsk sprouts from the taiga. Every year its skyline changes as apartments, theaters, and shops rise. Lured by higher pay and more living space than in European Russia, new arrivals take jobs at a huge aluminum plant, a wood-products



KODACHROME © NATIONAL GEOGRAPHIC SOCIETY

factory, or a hydroelectric project. About 140,000 people now live in the booming city and its satellites; city planners anticipate a future population of 300,000. The original Bratsk, a frontier outpost, lies buried under the reservoir created by the power dam.

As we peered into a particle accelerator, he continued: "The colliding electrons and positrons here generate energy that, particle for particle, is several thousand times greater than that of the H-bomb. New fuels can be developed that will be a billion times hotter than contemporary fuels. With such fuels, man can go to faraway planets. Not many people realize how close we are to such energy."

"Doesn't all this power you are unleashing frighten you?" I asked.

"Why should a man be frightened by being armed with a rifle in the jungle? For man, nature is the jungle and this energy is our rifle."

The man and the institute were enormously impressive, but as we walked through a laboratory, I noticed that the Russians, like me, have still not solved the problem of how to make the linoleum lie flat.

Favored Classes in a Classless Society

It has been suggested that a new ruling class exists in the Soviet Union: the children. But not far behind them, in terms of privilege, are the scientists. Top scientists at Science Town can, if they wish, occupy private homes on big plots in the forest, served by quiet, winding streets.

A young scientist who lived with his wife in one of these houses took us for a ride on the Ob' Sea in his new boat (opposite). His was one of four or five hundred boats tied up at the local marina.

While we cruised, he told me why he had come to Siberia. "Science Town is not crowded like Moscow, and there are many opportunities here. I go abroad once or twice a year and have been to most of the European countries and to Canada. It's not far by plane to Moscow; I go there on business seven or eight times a year. I probably see more first-night performances now than when I lived in Moscow.

"But, most important, I came here because of the challenge of my work. In a new city, we work only on new ideas."

Later, at the end of my Siberian travels, I sat in the modern airport in Novosibirsk. As I waited for the Moscow plane, I recalled a wonderful exile song that I had heard one night at the timber camp, sung by a lumberman, grandson of an exile. He had a deep, rich voice and steel teeth that glinted in the firelight. I had asked for a translation, and now I took it out of my pocket and read:

*Glorious Sea—Sacred Baykal,
Glorious ship—barrel of fish.
Hey, wind, stir up the wave,
We don't have far to sail, good fellow.
Long I carried heavy chains,
Long I roamed the Akatuy mountains.
An old comrade helped me escape,
I was born anew. . . .*

So it may be, I think, with Siberia itself.



Siberian "think factory": Top scientists work and play at a campuslike community near Novosibirsk. Only an idea a decade ago, Akademgorodok, or Science Town, houses 20 research



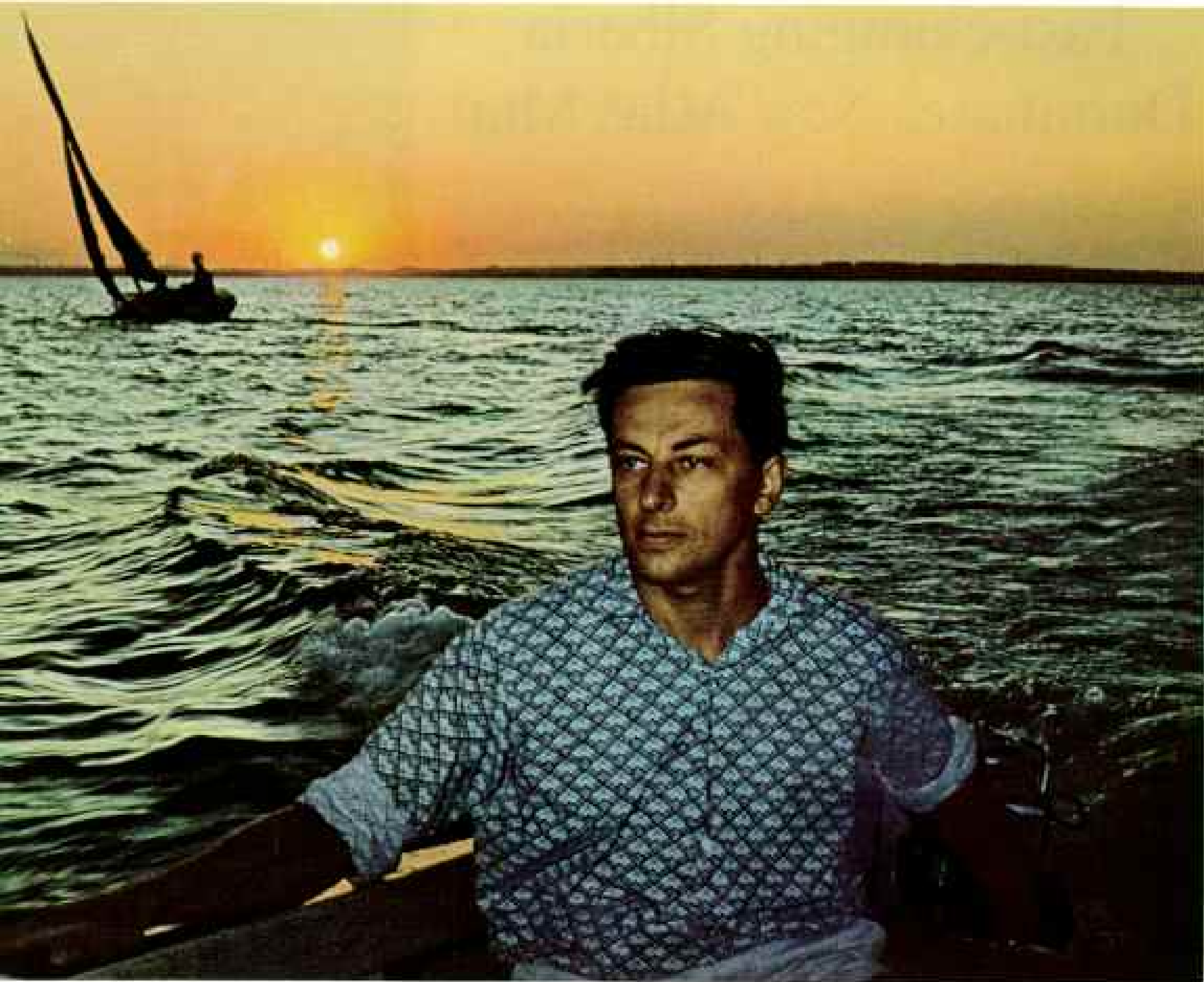

organizations that plan the Soviet Union's tomorrow. Officials of one of them, the Institute of Nuclear Physics, convene in a shirt-sleeve session (below). A colleague, Yevgeniy Abramyan, takes an after-work spin in his motorboat on the Ob' Sea, actually a reservoir (above). Like an American suburbanite, Dr. Abramyan drives to work in his automobile from an individual home in a wooded neighborhood of curving streets.



Fast-changing Siberia Dominates New Atlas Map

Yesteryear and today: Sea of mud served as a street for a Siberian town that was called Verkhne Udinsk when the picture below appeared in the May, 1921, NATIONAL GEOGRAPHIC. Present maps show it as Ulan Ude, capital of the Buryat Autonomous S.S.R. In Novosibirsk (right), as in other Siberian cities, trolleys and buses now bear residents along broad, paved avenues between ranks of apartment buildings.



TO GENERATIONS OF RUSSIANS, the word "Sibir" had a dreadful ring. Under tsar and Bolshevik alike, Russia's vast eastern territory became synonymous with exile and death. A grim parade of convicts and political prisoners disappeared without trace in its frozen reaches.

Although it still has labor camps, a vastly different Siberia emerges today—a rapidly developing land of incalculable wealth. Furthermore, this 4,403,100-square-mile titan shares a border with the Soviet Union's estranged ally—Red China. Thus a vital area of promise and conflict becomes a focal point of your Society's newest World Atlas Map, **Eastern Soviet Union**, a supplement to this issue of the GEOGRAPHIC.*

Secret Chinese and Russian Test Centers

Spanning northern Europe and Asia from the Baltic to the Bering Sea, the map includes the entire Russian Arctic and extends south beyond the Mongolian Republic, a buffer on the 4,150-mile-long Sino-Soviet border.

Somewhere near Lop Nor, a lake in Sin-

kiang (map square J19), Chinese scientists last fall test-launched their first nuclear missile. The new base lies only about 500 miles from Soviet soil. Northwestward across the frontier, small red rocket symbols indicate Soviet space and missile test centers at Kapustin Yar (H10) and Tyuratam (H13).

A rocket also marks Plesetsk (E8-9), 500 miles north of Moscow. This site, like Vandenberg Air Force Base, can launch satellites into polar orbit. Its existence was an intelligence secret until last October, when a group of British schoolboys detected it by tracking Soviet satellites. Their equipment: a second-hand radio and a borrowed globe.

The vastness of Siberia—all that part of the Soviet Union east of the Urals and north of the Kazakh Republic—challenges Russian energy and vision. It covers an area nearly half again as large as the contiguous United States. Within its borders flow four of the

*Additional copies of the 19-by-25-inch World Atlas Map, **Eastern Soviet Union**, may be ordered postpaid for 50 cents each from Department 382, National Geographic Society, Washington, D. C. 20036.



GREENWICH AND DUBLINWOOD (OPPOSITE); BODACHROME BY DEAN CONGER © N.G.S.

world's great river systems—the Ob', Yenisey, Lena, and Amur—and it holds more than 1½ million square miles of forest, whose northern limits appear on the map as a line of tree symbols. Beyond stretches desolate tundra.

Airports Hold Key to Ice-locked Prize

Temperatures as cold as -96° F. add a fearful hazard to pioneering. Yet man steadily conquers this forbidding prize. Red stars on the map indicate an expanding network of airports that provide access to areas barren of roads but rich in minerals, oil, and furs.

Complementing Dean Conger's vivid article on the preceding pages, the map also conveys the latest information on oil fields, pipelines, dams, canals, roads, and railways.

The world's longest rail line—the 5,780-mile Trans-Siberian Railroad—joins major outposts of expansion between Moscow and the Pacific Ocean, skirting the world's deepest lake, Baykal, en route. Trains take more than a week to complete the journey.

Siberia's northern rim reflects Russia's drive to utilize polar waters. The shipping

season is short, even in the era of giant ice-breakers such as the nuclear-powered *Lenin*. Blue dashes trace Arctic ship lanes—open, as a rule, only from mid-July to late September.

Still farther north lies a landmark in United States exploration of the Soviet Arctic. Glacier-capped Ostrov Graham Bell honors the inventor of the telephone. An expedition supported in part by the National Geographic Society reached the island in 1899 and named it for Dr. Alexander Graham Bell, the Society's President from 1898 to 1903. The expedition leader was a noted explorer, Walter Wellman, grandfather of National Geographic Chief Cartographer Wellman Chamberlin.

Not all Russian expansion has followed the peaceful pattern of today's development in Siberia. For historical perspective, the new map traces Soviet borders prior to World War II. The previous boundaries—saw-toothed red lines—show Soviet expansion into formerly non-Communist areas such as Estonia and Latvia in the west and the Kuril Islands and the southern half of Sakhalin Island north of Japan.

THE END

The National Gallery

IN THE PAST 26 YEARS, more than 37,000,000 people have visited the National Gallery of Art in Washington, D. C. The one I remember best is one I never met—a high-school girl from Pennsylvania who sent me a letter describing her experience.

“As I stood before El Greco’s painting of ‘The Virgin With Saint Inés and Saint Tecla,’” wrote the girl, “I was overcome with awe and reverence. I could not believe that I was ac-

tually seeing the original painting. For a moment I was transported to Spain of the 16th century. I felt as though I were looking over El Greco’s shoulder as he skillfully applied his brush and paint to the canvas. Hot tears smarted my eyes. I tried to conceal my sudden burst of emotion. So this is what it feels like to stand in the shadow of the great!”

Sometimes I receive more idiomatic comments. A girl from Toronto wrote in our



After a Quarter Century

Visitors' Book: "Man! I mean Man, like Wow! I am a real gone cat after seeing all this!"

And I remember a man at the other extreme of life. In the early 1940's, when the Gallery was new, I often noticed Adolph Caspar Miller, a noted economist and onetime member of the Board of Governors of the Federal Reserve System, engrossed before a relentless self-portrait painted by Rembrandt in 1659, when he was 53 and bankrupt. Shortly

before his death, Mr. Miller told me that he had bequeathed funds for future purchases as well as his own fine collection of paintings to the National Gallery—as payment, he explained, for the insights given him by that sad and ravaged face.

The greatness of art lies in its capacity to heighten our perceptions and engage our emotions. Certain Van Gogh portraits, in their harrowing intensity, can evoke all the "pity and terror" that Aristotle ascribed to tragic drama. Fragonard, on the other hand, can draw you into a world of luminous serenity (page 353). Renoir, in his "Girl With a Watering Can," even re-creates childhood; the quality of the sunlight and the flowers in this painting, along with subtle alterations of perspective, show us the world through a child's eyes. We see it, and we remember.

Substance Comes to Art-lover's Dream

For more than 25 years I have observed—with endless fascination—the confrontation of man with art at the National Gallery. I joined the staff in 1939, almost two years before the Gallery actually opened its doors. I have seen it progress from infancy, when barely 700 paintings graced its walls and the majority of its exhibit rooms were unused, through a burgeoning adolescence that saw the acquisition of some 30,000 works of art, to a present maturity that will, hopefully, extend the benefit of our facilities to every family and every community in the Nation.*

The National Gallery represents the dream of a great lover of art—Andrew Mellon, Secretary of the Treasury in the Cabinets of Presidents Harding, Coolidge, and Hoover, and

*The author has also written for NATIONAL GEOGRAPHIC: "The Nation's Newest Old Masters," November, 1956; "Your National Gallery of Art After 10 Years," January, 1952; and "American Masters in the National Gallery," September, 1948.

Alone with beauty, a young visitor to the National Gallery of Art in Washington, D. C., dreams in this house of treasure. Fiery blossoms of a Chinese hibiscus adorn the East Garden Court. In just 26 years, donations of private collections and individual paintings have made the National Gallery one of the world's great museums.



STYLING BY VIVIEN WISDOMA © N.G.A.



Masterpiece in marble houses a matchless heritage. When financier Andrew Mellon promised his art collection to the Nation in 1936, he also provided funds to construct a suitable home. Architect John Russell Pope designed spacious wings flanking a stepped dome and Ionic porticoes. The founder's profile (below) graces the lobby. In 1941—3½ years after Mellon's death—his gift to the American people was dedicated by President Franklin D. Roosevelt. Front



NATIONAL GALLERY OF ART



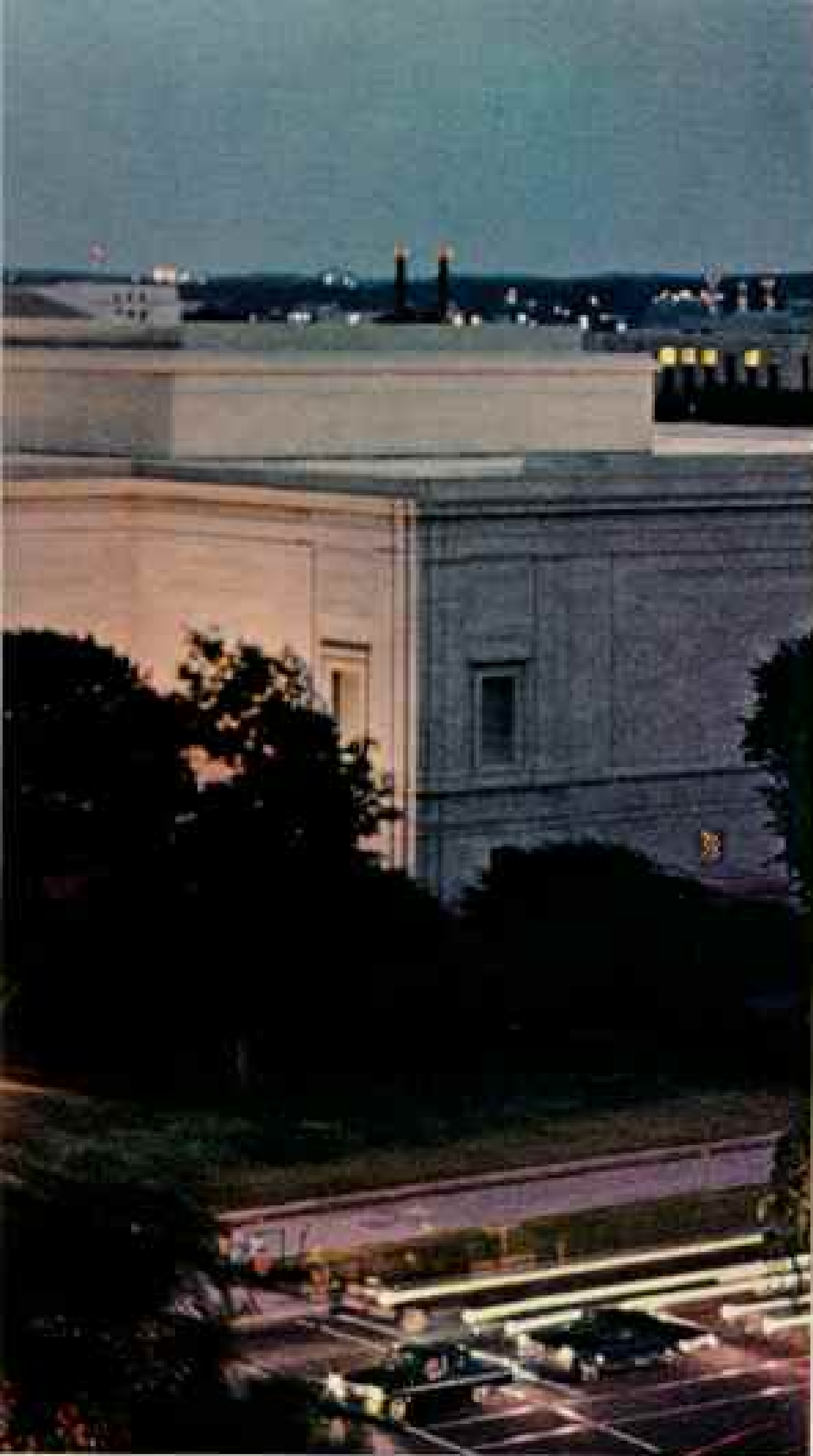

ARCHITECTURE BY JAMES W. BRUNN © N.G.A.

row, from left: Samuel H. Kress, who also gave his collection to the Gallery; Paul Mellon, son of the founder; Chief Justice Charles Evans Hughes; the President; Mrs. Roosevelt; Vice President Henry A. Wallace.

later Ambassador to the Court of St. James's. Throughout his life, Andrew Mellon collected old masters. At some point, he conceived the idea of founding a gallery in Washington to rival the venerable art museums of Europe.

In 1936, he offered to erect such a gallery and to donate his own brilliant assemblage of 111 paintings and 21 pieces of sculpture. On March 24 of the following year, President Franklin D. Roosevelt approved the Joint Resolution of Congress authorizing acceptance of this generous proposal. With characteristic modesty and concern for his countrymen, Mr. Mellon indicated two wishes: The gallery should not bear his name, and no admission fee should ever be levied.

Gallery's Beauty Enhances Paintings

As an edifice, the Gallery itself seems to me a work of art (left). But unhappily, neither Mr. Mellon nor its architect, John Russell Pope, ever saw the completed structure. They died within a day of each other in August, 1937, soon after work commenced.

I remember, upon joining the staff, being impressed by the cost of the building—\$15,000,000. Today, assuming that one could find the equal of the stonemasons and other craftsmen who labored for four years on it, this figure might be three times as much.

Sometimes, I confess, I think that the building is almost too successful, that it distracts visitors from the art that it houses. The dignity, splendor, and permanence of the architecture offer a visual satisfaction too rarely realized in our public buildings.

Since paintings are better lighted from above than from the side, the architect surrounded the exhibit areas with windowless walls. Thus the exterior presents an almost



solid marble surface 65 feet high and, in the sum total of its four sides, almost half a mile in length—making the National Gallery one of the world's largest marble buildings.

These exterior walls exemplify the painstaking approach of the builders. Because of the Gallery's size—it is longer than the U. S. Capitol—they felt that the reflection of the sun on a massive white exterior would produce a harsh glare. So they specified a delicate rose-hued marble from Tennessee.

Marble Giant Built in Three Parts

The first shipments revealed several differing shades of marble. To impart a uniform color to the masonry, experts classified each block at the quarry so that the deepest rose would be at the base, with subsequent courses rising in gradually paler strata to create the illusion that the building was actually a uniform rose-white tone.

Eight hundred railroad cars carried the precut marble from Tennessee to Washington, and the Southern Railway constructed special metal covers for the gondola cars so that no soot would discolor the marble en route.

The huge bronze-and-steel doors of the Gallery's main entrance—32 feet tall and 6 tons each in weight—open onto the Rotunda, remi-

niscent of Rome's 1,800-year-old Pantheon. Observant visitors will find, as they enter either wing, a bronze joint bisecting the floor. Visible only underfoot, it actually runs up the walls and across the roof. The Gallery is built in three segments, and these overlapping joints slide to allow for expansion and contraction from heat and cold.

In the planning stage, the Gallery adopted a policy of displaying works of art in settings of maximum effectiveness. We have never compromised that principle. Our paintings hang at wide intervals so that each, bracketed by empty wall space, may be viewed in relative isolation. And our 123 individual exhibit rooms differ widely in decor. Early Italian paintings are placed against travertine stone and plaster walls; the opulence of later Italian paintings is set off by damask. Dutch, Flemish, and Spanish paintings are hung against oak paneling, and light-colored panels provide an 18th-century background for French, English, and American pictures of that period.

A quarter of a century later, I can confess that we who steered the new National Gallery out into the tricky crosscurrents of the art world constituted a remarkably amateurish crew. David E. Finley, the first Director, was a lawyer and a former special assistant to

ENTRANCE BY JAMES L. STOVYER, BLACK AND WHITE © N.G.A.





NATIONAL GALLERY OF ART © N.G.A.

"A Young Girl Reading" was painted by Jean-Honoré Fragonard about 1776, at the height of his career. Mrs. Mellon Bruce, Andrew Mellon's daughter, presented the work to the Gallery.

Anyone may copy a painting with permission from the Registrar. Using a free easel and stool lent by the Gallery, a young artist tries to match Fragonard's hand.



Andrew Mellon. Administrator Harry A. McBride came from the Department of State. I, as Chief Curator, had never served on a museum staff, although I had spent three years as an assistant to Bernard Berenson, one of the great art authorities of this century, and had for four years directed the Fine Arts Department of the American Academy in Rome.

Perhaps our lack of professional prejudice was an actual advantage. We were unaffected by museum fashions; we were willing to take chances, to pioneer. But above all we were lucky in our timing, and the National Gallery grew faster than any similar institution in history. Unless European museums disperse their collections, which is unimaginable, no gallery founded today could amass works of equal importance. After all, only so many Raphaels, Titians, or Rembrandts exist—and virtually none remain in private hands here, and very few in private hands abroad.

But the National Gallery came into existence at the right moment. The United States boasted several great private collections of old masters, and we were fortunate enough to attract nearly all of them.

When Mr. Mellon offered his own paintings and sculpture to the Gallery, he hoped it would bring similar gifts. Responding to this stimulus, Samuel H. Kress presented an incomparable cross section of 13th-to-18th-century Italian art—thus helping to fill vast empty spaces on the Gallery's walls at its official opening on St. Patrick's Day, 1941.

Nor did Mr. Kress stop at this munificent gesture. The Samuel H. Kress Foundation went on to spend, between 1945 and 1956, more than \$25,000,000 on additional masterpieces to broaden the scope of the original gift.*

*In "The Kress Collection: A Gift to the Nation," NATIONAL GEOGRAPHIC, December, 1961, Guy Emerson told of still other Kress donations to U.S. art museums.



REPRODUCTION BY NATIONAL GEOGRAPHIC PHOTOGRAPHER WINFIELD PERRY © N.G.A.

Looking back on the sums we paid for paintings and sculpture acquired prior to the past decade, with its spectacular rise in prices, I would rank these Kress purchases among the best investments of our time.

Seven-hour Plea Wins Art Works

Acquisition of the Kress Collection by the National Gallery stemmed from the persuasive powers and excellent timing of David Finley. When he first approached Mr. Kress, architects had already been commissioned to plan a private museum to house the Kress Collection in New York. But, after a seven-hour conversation, the Gallery's first Director induced Mr. Kress to deed his paintings to the Nation. Had David Finley arrived even a few weeks later, the Kress Collection and the vast benefits that flowed from it would have been lost to the National Gallery.

In 1943, a third magnificent contribution—

Guardians of priceless art: Paul Mellon, President of the National Gallery, and Director John Walker examine Dutch and German masterpieces stolen from the Grand Ducal Weimar Museum in Germany 45 years ago and now homeward bound. Thieves in 1922 cut from their frames Rembrandt's "Self-Portrait," painted when he was 37 (on the easel); "Portrait of a Man" by Gerard Ter Borch, held by Mr. Walker; and "Portrait of a Young Woman" by Johann Tischbein. In 1946 the wife of an Ohio businessman who had purchased the paintings from a seaman took the still-rolled canvases to the Dayton Art Institute for evaluation. Quickly recognized, they were turned over to the Department of Justice as enemy property and deposited in the National Gallery for safekeeping. Congress recently enacted legislation to return them to Germany.

the collection of Peter A. B. Widener and his son Joseph E. Widener—went on exhibit. The Wideners' donation of 2,598 works of art included paintings, sculpture, bronzes, jewelry, furniture, tapestries, and porcelain.

When Chester Dale died in 1962 he bequeathed to the Gallery a superb assemblage of French paintings that catches all the excitement of Impressionism, Post-Impressionism, and the School of Paris, represented by giants of modern painting from Manet to Matisse.*

Lessing J. Rosenwald presented an array of more than 20,000 examples of the graphic arts. The collection extends from early woodcuts and engravings to the most recent silk screens and complex intaglios. It is an anthology of prints ranking in quality with the greatest in the world.

Some 200 other donors have also given works of art, justifying the faith of Andrew Mellon in the museum he envisioned. For the National Gallery stands as a peculiarly American achievement—built and endowed by an individual, displaying masterpieces presented to their Nation by selfless citizens.

While great paintings and sculpture are the *sine qua non* of any gallery, their acquisition represents only the opening gun of a tricky battle. For every museum must fulfill two vital responsibilities toward its treasures—presenting them dramatically to viewers and preserving them effectively for posterity.

To illustrate the first of these functions, consider one of the Gallery's most recent purchases—"St. George and the Dragon," a postcard-size masterpiece long attributed to the Flemish artist Hubert van Eyck. When

*See "Great Masters of a Brave Era in Art," by Hereward Lester Cooke, Jr., *Geographic*, May, 1961.



Thumb-size hero slays a three-inch foe. "St. George and the Dragon," reproduced here actual-size, sold at a London auction in 1966 for \$616,000, a record for so small a masterpiece. Gallery experts now believe the 500-year-old painting, long thought to be the work of Hubert van Eyck, was actually done by a contemporary, Rogier van der Weyden.

Built-in magnifier in a glass case helps a visitor view the 15th-century Flemish miniature. With extraordinary delicacy, the artist painted the intricate detail of the endangered princess's gown, the minuscule horses and riders in the background, and the crenelated castle and buildings of the town. The Gallery protects its masterpiece with a specially designed case, so constructed that the slightest jar will set off an alarm in the guard office.

NATIONAL GALLERY OF ART, ENTHRONING (BELLEVUE) BY JAMES L. STANFIELD, BLACK STAR © N.G.A.



the British auction house of Sotheby's announced that the 5⁵/₈-by-4¹/₈-inch painting would go on the block early in 1966, Chief Curator Perry B. Cott and I both hurried to London to examine it. We decided that we should acquire this exquisite panel (opposite), and the Trustees agreed.

Following standard practice in the art world, we secretly commissioned a British dealer to act as our agent in the bidding. I cannot hope to convey the drama of the auction, but in the end the work was sold to our representative for \$616,000. This amounts to \$26,552 per square inch, and, on that basis, the miniature may rank as the most expensive painting in history. But, given the spiraling prices of great art, the Gallery acquired it for a surprisingly modest outlay, drawn from the Gallery's Ailsa Mellon Bruce Fund.

Once "St. George and the Dragon" arrived in the United States—carried via transatlantic aircraft in the pocket of our bidder—the staff studied it carefully. Infrared and X-ray photographs, and meticulous inspection by microscope, showed a remarkable state of preservation. From the brushwork, the style, and the cool tonalities, we decided that the previous attribution to the shadowy Hubert van Eyck was incorrect. Instead, we believe that this holds a significant place in the work of Rogier van der Weyden, an equally important 15th-century Flemish artist.

Ultrasonic Waves Protect Masterpiece

Then, to Chief Curator Cott fell the problem of how best to exhibit this minuscule masterpiece. Van der Weyden painted "St. George and the Dragon" with unbelievably minute details—for example, a perfectly executed horse and rider in the background encompassed in barely ¹/₁₀ of a square inch—indicating that the artist must have employed magnification. So Mr. Cott's solution brought the painting full circle. The Gallery displays it inside a specially constructed glass case. Mounted in the glass, a magnifier five inches in diameter—Mr. Cott's own, as he often reminds me—enables the viewer to see every particular of Van der Weyden's incredibly contracted, incredibly lovely world.

Anyone who shifts his eyes from the painting to the protective case may note two small round cells in the corners. One, a tiny transmitter, emits an ultrasonic signal; the other receives it. Any impact on the glass enclosing "St. George and the Dragon" would alter the

pattern of these inaudible sound waves, causing a bell to clang in the Gallery's guard office. This sophisticated burglar alarm epitomizes the protective measures we employ.

As someone pointed out to me in amusement, whenever a member of our staff discusses security, he knocks on wood—and with reason. Through a combination of luck and care, the National Gallery stands virtually alone among the world's major art museums in never having suffered a theft.

To appreciate the threat to a masterpiece every time an art museum opens its doors, consider the outrages perpetrated against Leonardo da Vinci's "Mona Lisa" in our century alone. In 1911 a thief spirited it out of the Louvre, and it was not recovered until 1913. In 1956, a visitor hurled a stone at the painting, chipping the surface.

Guards Succumb to Spell of Art

So we are uncompromisingly alert. Our 135-man guard force keeps 24-hour watch over an art assemblage that represents, beyond its astronomical dollar value, some of the most sublime attainments of the human race. What we protect is not canvas and pigment, wood and stone; it is the heritage of man's ceaseless search for beauty and meaning.

When the Gallery is open, guards are so stationed that every work of art and every visitor remain under constant surveillance. Closed-circuit television keeps unblinking watch on crucial areas, and an alarm system can seal every exit in seconds.

When the Gallery closes at the end of the day, guards comb every cranny to ensure that no unauthorized person lingers in the building. Throughout the night, guards patrol the galleries, checking every painting, every statue. They have recently acquired a fearsome ally in their nocturnal rounds—a huge German shepherd named Prince, trained by the District of Columbia Police Department. All night long Prince pads the dim galleries sniffing suspiciously (next page). Mercifully, he has flushed no quarry to date—except purposely concealed decoys to keep him alert.

I do not know if Prince has yet succumbed to the spell of art—he may find his first enchantment in the belled and ribboned little pug dog that minces across Goya's portrait of the Marquesa de Pontejos—but several of our hard-boiled, efficient guards have.

As one told me after making a midnight round, "I'm responsible for these paintings,

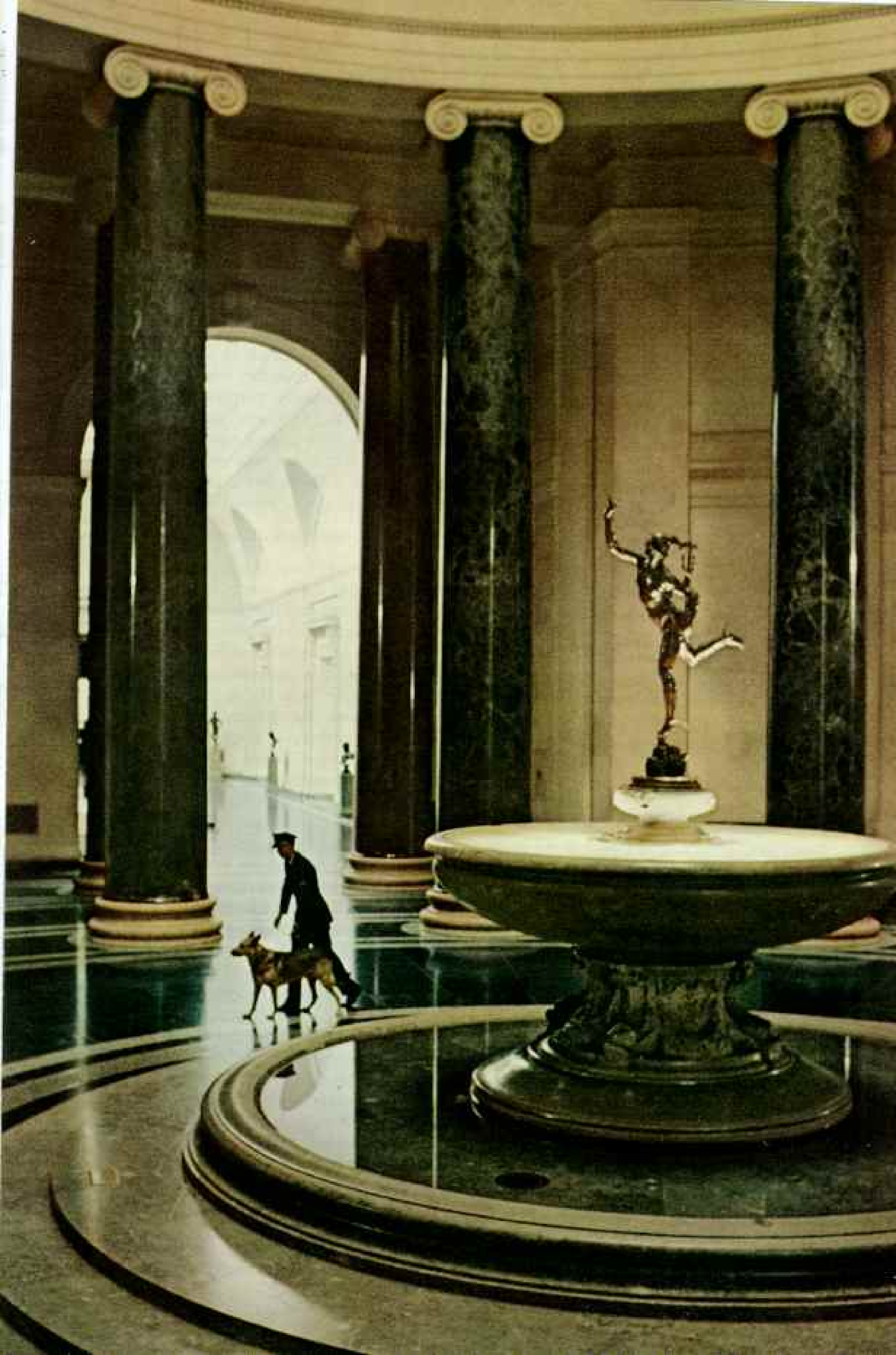

so I check them out purely as objects. But when things are going smoothly and I'm a minute or two ahead of schedule, I love to pause and soak up a Fragonard or a Boucher."

In protecting the precious works against the depredations of fellow humans, we meet only half our responsibility; we must also guard against nature. Wide swings in temperature and humidity blister paint and separate it from wood or canvas backgrounds. The National Gallery has always been completely air conditioned, with humidity under constant control. This stability of atmosphere benefits the works of art and increases their life expectancy; the resultant comfort for visitors comes merely as a happy dividend.

Basic research pioneered by the National Gallery has shown that daylight and even artificial light also menace paintings. It is

largely fortuitous that our old masters retain their radiant hues. For hundreds of years they hung in dark churches and palaces. By the 19th century, when they emerged into skylit museums, they were covered with dirt embedded in layers of yellow varnish. This obscuring film filtered out the light, so that relatively little reached the pigment. In our century we have generally cleaned away this protective coating and revealed pictures in their original brilliance, at the same time exposing them to greater amounts of light.

The effect of light on oil and tempera paintings was first brought to my attention by Ernest Feidler, then Administrator of the Gallery. He noticed that our stained floors had faded where sunlight played over them. If a floor changed hue, surely something might also be happening to our paintings.

I had long believed that the physical sciences could provide the key to many artistic problems, so, in 1950, the National Gallery—aided by the Old Dominion and Avalon Foundations—launched a research project under the direction of a chemist, Dr. Robert L. Feller. In the 17 years of its existence, the project has funneled to the art world a series of discoveries profoundly affecting the preservation and display of art works.

Invisible Light Takes Worst Toll

Dr. Feller soon showed that much of the damage inflicted by light on objects of art stems from ultraviolet radiation, invisible to the eye. Translating this information into action, the Gallery installed special Plexiglas panels in its skylights; these filter out the harmful ultraviolet rays, while permitting visible light to enter. This has greatly reduced the problem of fading, but more must still be done, and our studies continue.

The laboratory has also developed new protective varnishes that do not yellow with time and can be easily removed. Other investigations have shown why some "fugitive" pigments lose their brightness, and this has led to improved varieties that will not fade.

Another new method—similar in principle to the carbon-14 dating system that has revolutionized archeology—measures the rates of radioactive decay of certain components in white-lead pigment. Once perfected, this procedure should be of great utility in detecting modern forgeries of old masters.

An incredible assortment of talents and facilities buttresses the seemingly routine operations of an art museum. When you visit



STYLOPHUMES BY NATIONAL GEOGRAPHIC PHOTOGRAPHER ARDREY BRIDSON (ABOVE) AND JAMES L. STANFIELD, BLACK STAR © N.G.S.

Blazing tracer bullet streaks toward the target above a remote-control camera as Capt. F. E. Kenney of the Gallery's 135-man guard force practices in the sound-proof top-floor pistol range. In 26 years, the Gallery has had no thefts.

Prince on patrol: A highly trained German shepherd and his handler Franklin Mathews make nightly rounds past the Rotunda fountain, which bears the 16th-century "Mercury" of Giovanni Bologna.



First Lady presents gold medals and \$500 prizes to art educators honored by the Gallery as part of its 25th-anniversary celebration. Miss Olga Schubkegel (below) of Hammond, Indiana, and other primary, secondary, college, and graduate-school teachers received the awards in the East Room of the White House. Mrs. Johnson cited their success in enriching the lives of young people through greater understanding of art.



National Gallery celebrates its 25th birthday in the great Rotunda, ringed by soaring columns of green-black marble. The United States Marine Band plays beside the fountain; clusters of white azaleas resemble decorations on a cake. "A never-to-be-forgotten evening," said Mrs.



SOBACHONES BY NATIONAL GEOGRAPHIC PHOTOGRAPHERS R. FREDERICK STEWART AND ARLAN R. WIKER (ARROW), ROBERT S. JAMES (UPPER LEFT), AND LANCE P. BLAIR © N.G.S.

Johnson, after she and thousands of other honored guests viewed for the first time the combined collections of 19th- and 20th-century paintings loaned for the 25th anniversary by Mr. and Mrs. Paul Mellon and Mrs. Mellon Bruce. The exhibition last spring contained nearly 250 paintings and drawings. Some 50 of Mr. and Mrs. Mellon's paintings, including many of those reproduced on pages 372-85, remain on display today as a long-term loan to the Gallery.



EXCERPTED BY EMMY KRISTOP LARIVEI AND B. ANTHONY STUART © N.G.A.



Art detective and Curator of Painting for the National Gallery, H. Lester Cooke, Jr., points out to Mrs. Peter D. Beter a part of another subject beneath a still life that she and her husband purchased at an antique sale. Once a week, from September to July, Dr. Cooke examines works brought in by owners hoping they have masterpieces. Ultraviolet-light scrutiny of writing on the back of the Beters' painting had led Cooke to believe another work might lie under the cascade of flowers.

X-rays proved him right. A restorer removed the overlayer to reveal a 19th-century painting (left) of the Madonna appearing in a vision to children.

Change of mind two centuries ago by artist Giovanni Battista Tiepolo shows in an X-ray picture, right, of "A Young Lady in Domino and Tricorne." Noticing an unusually thick layer of paint in the area of the fan, Resident Restorer Francis Sullivan investigated and discovered that the artist had originally depicted an open fan.

the National Gallery, you witness a culmination of the efforts of more than 300 employees, ranging from custodians to curators.

If you toured the recesses of the Gallery, you would discover two carpenters turning out frames, stands, display cases; a metal-smith at work in a completely equipped shop; a studio where photographers make precise "record shots" of every item in our collection. Because color film fades, we must rephotograph everything periodically. Thus the Gallery maintains a file that duplicates every color and form in our possession.

In the basement you would find our heating and cooling and electrical systems—also in duplicate. We cannot risk a failure that would threaten the security or condition of a work of art. A 48-inch pipe brings water from the Tidal Basin to cool our air-conditioning units, which would require far too much city water. One of our rather odd jobs is to remove the small fish that flow in with the water.

Anyone strolling the upper reaches of the building might hear a series of faint pops. Upon opening a certain door, he would enter a pistol range where members of our guard force maintain their quickness of reflex and sharpness of eye (page 359). We are quite serious, you see, about protecting the works of art.

Outside, in a moat concealed from the Mall, you might see our six gardeners at work in their greenhouse. Horticulturist Noel Smith not only bears responsibility for the care and landscaping of our seven outside acres, but he must supply some 5,500 varied plants—azaleas in spring, lilies at Easter, hibiscus in summer, chrysanthemums in autumn, poinsettias at Christmas—for decoration inside.

Visitor From Paris Packs the House

When asked to pinpoint the most exciting event in the Gallery's short history, I can answer without hesitation. In fact, I recall it vividly three times each day—when I swallow pills to calm the nervous indigestion left in its wake. I call them my "Mona Lisa" pills.

In 1962 the French Government, through the good offices of the Minister of Cultural Affairs, André Malraux, agreed to entrust the "Mona Lisa" to President and Mrs. John F. Kennedy for exhibition at the National Gallery and, by subsequent arrangement, at New York's Metropolitan Museum of Art. The President delegated responsibility for the exhibition and safe return of this priceless masterpiece to me.

The curators of the Louvre took a very dim view of the projected transatlantic trip

CATALANORE BY FREDERICK BRADLEY © NATIONAL GEOGRAPHIC SOCIETY



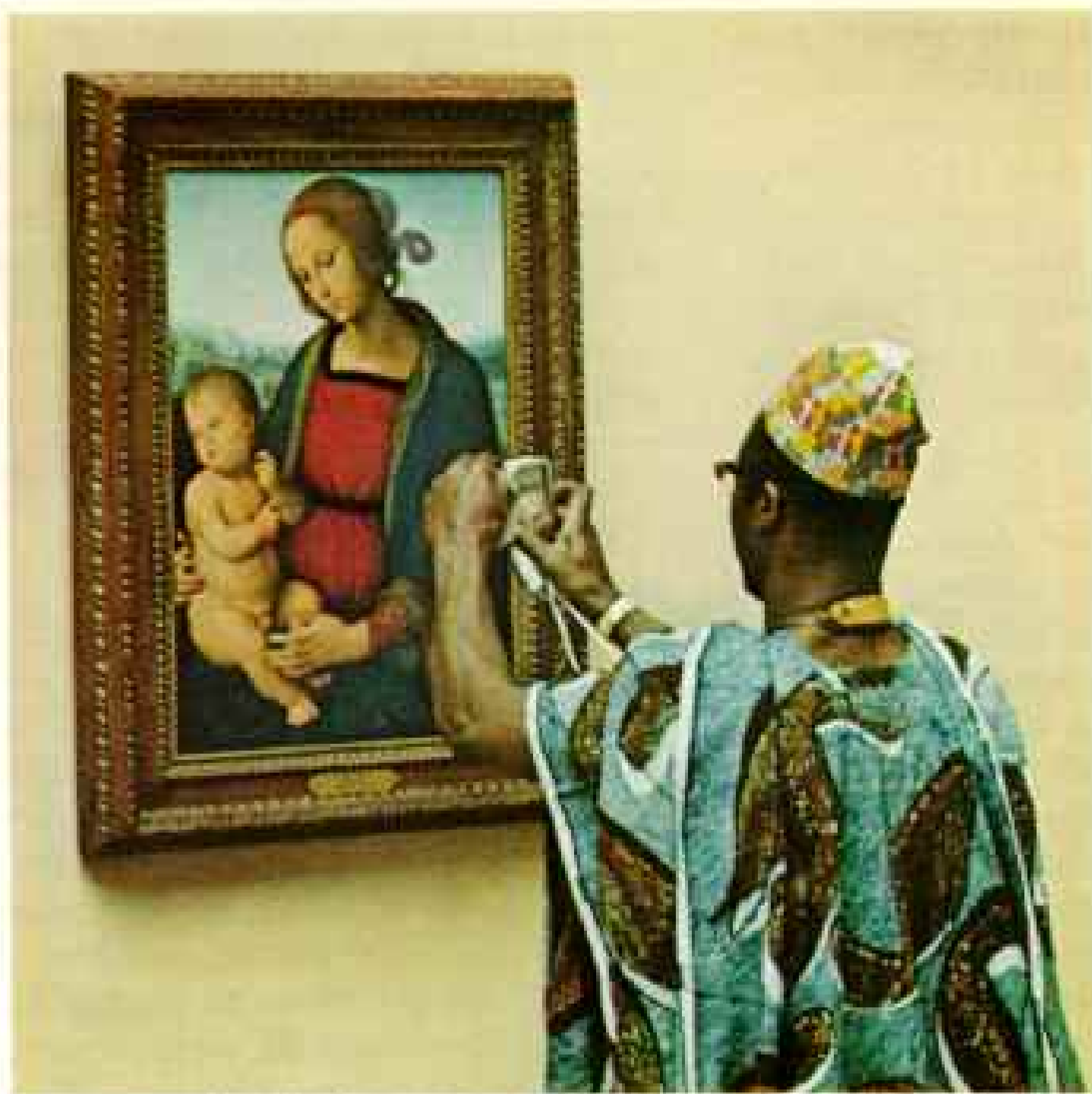

EXTRACOURTESY BY JAMES L. STREIFELD, BLACK STAR (RIGHT) AND KERRY HENDERIKS © N.G.G.

Photography permitted: Unlike many European art museums, the National Gallery allows the public to take pictures freely, with or without flashbulbs. A visitor from Africa obtains a light-meter reading of "Madonna and Child" by Perugino, a teacher of Raphael.

Power of faith, as painted by a master, enthalls visiting nuns. Peter Paul Rubens portrayed "Daniel in the Lions' Den" offering thanks for divine protection. The Gallery last year acquired the work, one of the few large oils painted in their entirety by the Flemish artist.

of their most famous possession. The "Mona Lisa"—painted on wood, not canvas—is, of course, fragile. X-rays show an incipient crack in the panel, and shifting temperatures and humidities of 450 years have caused it to bow perceptibly. Art experts regarded the venture as perilous indeed.

However, the Louvre fashioned an ingenious shipping case of aluminum—airtight, foam-insulated, and with a rigidly maintained internal atmosphere. This case, always carried by hand, crossed the ocean in a private cabin, with the two adjacent cabins occupied by guards and curators.*

Specialists determined the temperature and humidity in the Louvre, which is not air conditioned, at the moment the painting was committed to its case. A week later, when we unpacked the "Mona Lisa" in the National Gallery, we duplicated this temperature and humidity.

As the man responsible for the safety of the painting, how did I weather the 53 days when more than 1,500,000 people filed before it? Well, my wife had to keep sharp instruments away from me, and my digestive tract entered a permanent twilight. But, in retrospect, I would have it no other way. That towering cultural loan—which ended with absolutely no

*The story of "Escorting Mona Lisa to America" was told by Edward T. Folliard in the June, 1963, NATIONAL GEOGRAPHIC.

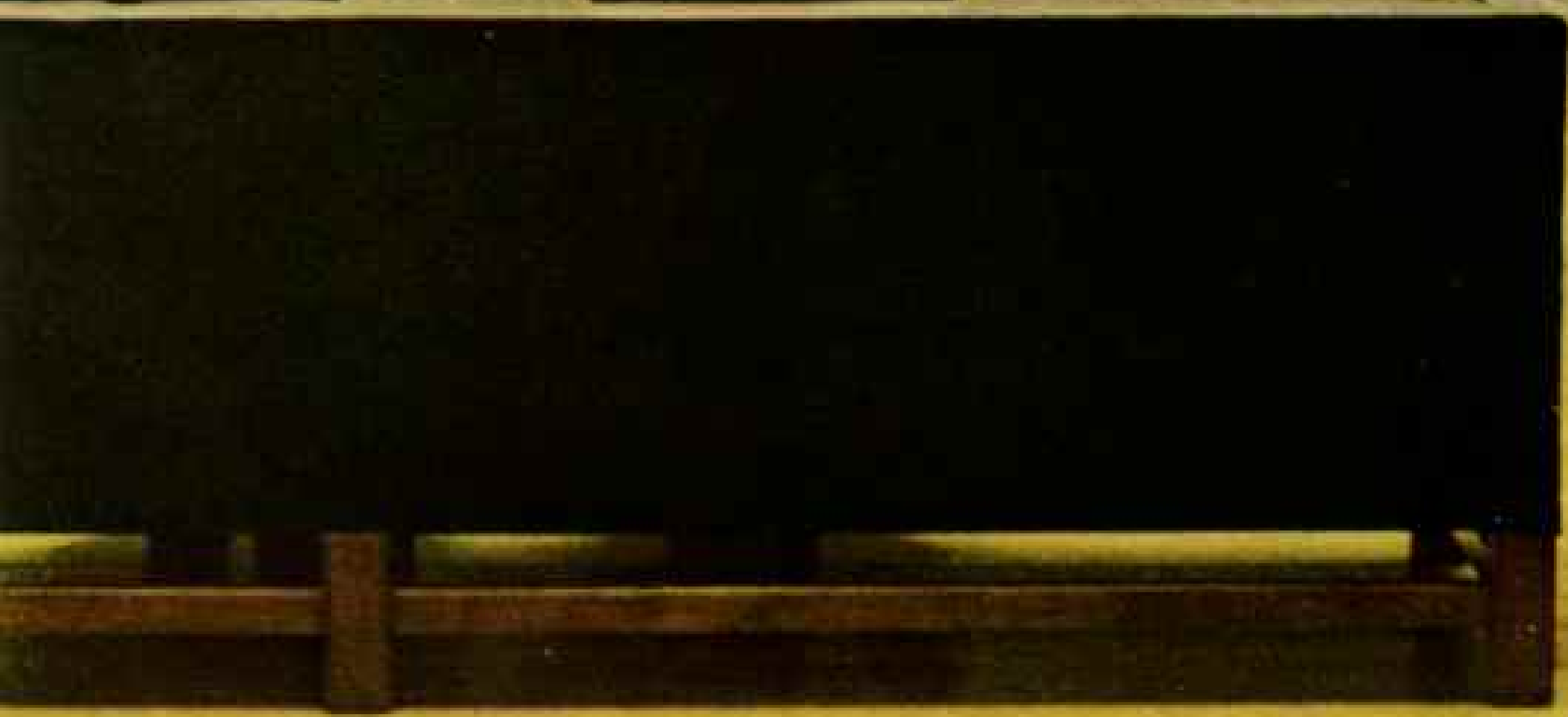

ill effect upon the "Mona Lisa"—proved that, with proper but immensely expensive precautions, even the most vulnerable painting may now be shipped across frontiers. Tragically enough, such precautions had never been taken before—and probably, because of the cost, will not often be taken again.

Two incidents remain in my memory: One distresses me, and one delights me. There was a man who asked a guard, "What do they use this building for when the 'Mona Lisa' isn't here?" And there was a small boy who waited

in line till he got in front of the picture, opened his overcoat, showed his dog Leonardo's masterpiece, and vanished.

To be candid, everyone responsible for the journey of the "Mona Lisa" caught stinging criticism within professional art circles. So perhaps I found a deeper poignancy in M. Malraux's remarks to the President of the United States and—via the Relay satellite—to Europe at the opening of the exhibit.

"There has been talk of the risks this painting took by leaving the Louvre," said M.



Malraux, himself a distinguished art critic who fought for freedom in the China of the 1920's, in Spain, and in France. "They are real, though exaggerated. But the risks taken by the boys who landed one day in Normandy—to say nothing of those who had preceded them 25 years before—were much more certain. To the humblest among them, who may be listening to me now, I want to say . . . that the masterpiece to which you are paying historic homage this evening, Mr. President, is a painting which he has saved."

EXTRACTS BY JONATHAN S. BLAKE © N.G.A.



The staff of the National Gallery has always been conscious of the fact that the fine arts do not thrive in isolation. Common bonds have always linked literature, painting, sculpture, and music. The late Ernest Hemingway said that the paintings of Cézanne, Monet, and Gauguin taught him much about writing. And the great 19th-century Russian composer Modest Moussorgsky found the inspiration for his soaring *Pictures From an Exhibition* in a showing of the works of the painter Victor Hartmann.

To preserve this unity of the arts, the Gallery maintains a symphony orchestra, as well as an extensive publications program. On Sunday nights, from September to June, in the green, leafy serenity of the East Garden Court, visitors may attend musical programs that range from plainsong to the symphonic dissonances of Charles Ives, from the ordered measures of Handel to the craggy ballads of the American Revolution (next page). In the spirit of Andrew Mellon, admission is free.

Gallery Premieres New American Music

Each spring the Gallery sponsors an American Music Festival devoted to compositions originating in this country. In its quarter-century of existence, the Gallery has presented the music of more than 400 American composers, and more than 200 of their works were first heard by audiences in the East Court. Music Director Richard Bales, conductor of the National Gallery Orchestra since 1943, has composed three orchestral and vocal suites that have become best-selling record albums. First performed in the East Court, they are *The American Revolution*, *The Confederacy*, and *The Union*.

Since scholarship is vital to a living museum, I have tried to emphasize this aspect of the Gallery's work. To train young people in the history of art, I annually recommend to our Trustees six outstanding graduate students for fellowships lasting one or two years. They study at the Gallery and in Europe.

The Gallery also supports the work of more mature scholars. With the generous assistance

Freedom to paint—made possible by a National Gallery grant—sent Brooklyn-born Gilbert Stone to Rome. Recommended by museum curators and fellow artists as a potentially significant artist, Mr. Stone won a Dale Fellowship from the Gallery. He displays recent work in his studio at the American Academy in Rome.



of the Bollingen and Kress Foundations and Mrs. Mellon Bruce, more than a dozen books by distinguished critics and historians have been, or will shortly be, published under the imprint of the National Gallery.

But the reputation of any museum depends on its own staff. In 26 years our various curators have published several hundred books and articles elucidating works of art in our collection or related subjects. One series, dealing with specific schools of painting, has sold almost a million copies.

Do You Own an Undiscovered Treasure?

Because our principal aim in publishing is to provide those joys to the eye that music conveys to the ear, we concentrate on color reproductions of the paintings we exhibit. To date, our Publications Department has sold more than 3,250,000 such reproductions in an 11-by-14-inch format at a price that has remained constant since the opening of the Gallery—a modest 25 cents each.

Not long ago, a man in Wisconsin sent us a check inscribed, "For treatment of a sick cow." He had re-endorsed it and forwarded it to buy reproductions of paintings that, he said, "I liked when I visited the Gallery."

Anyone who finds a dusty painting in his attic or buys a grimy figurine in an antique shop invariably wonders if, just by chance, he has a masterpiece. As a free subsidiary service, the National Gallery will resolve the doubts of anyone on this score by examining the object and giving an opinion on authenticity, date, and possible authorship.

Once a week, from September to July, hopeful owners converge on the Gallery to place their treasures before H. Lester Cooke, Jr.,

who presides over what he terms a "casualty ward for outpatients in the world of art." In the curtained corner of an office—Dr. Cooke calls it his "wishing tent"—he receives all comers with all sorts of art. Armed with camera, ultraviolet lamp, magnifying glass, and a fund of expert knowledge, he winnows paintings, sculptures, and prints.

Occasionally, but not often, a genuine find turns up in the wishing tent. At a session last year a couple appeared with a painting that had been stored for decades in a Boston attic. The previous summer they had brought it to Washington atop an automobile.

The painting depicted a bucolic scene and bore the signature "E. Boudin." It passed every test, one by one, as to style, brushwork, age. Finally, an ultraviolet examination ascertained that the signature was not a later addition. The painting proved to be a genuine work of the French 19th-century artist Eugène Boudin. While the Gallery never assigns a value to works thus authenticated, the couple could draw comfort from the knowledge that similar Boudins have commanded five-digit prices. They did not, incidentally, carry the painting home on the top of the car.

Music takes over on Sunday nights. From September to June the National Gallery Orchestra, smaller groups, or soloists perform amid the foliage of the East Garden Court. As many as 1,000 people attend the free concerts. Music Director Richard Bales (center) often presents contemporary American works and has introduced here three of his own compositions—*The American Revolution*, *The Confederacy*, and *The Union*.

Gallery grows its own flowers in a small greenhouse on the grounds. Azaleas for the Rotunda and East and West Garden Courts flourish under the care of Robert G. Miller, one of six staff gardeners.



GREENHOUSE LEFT BY G. LATHROP STEWART AND ELSIE S. WALKER.
AZALEAS BY EMORY BRISTOL © N.G.G.



Daddy, I want to hear too! From a jump seat on his father's back, young Christopher Bigenwald grabs the earphone of one of the Gallery's miniature radio receivers that give a guided tour and commentaries on works of art in 28 rooms. Mr. and Mrs. John Bigenwald, of Rochester, New York, like thousands of other visitors, rented the sets for 25 cents each. Tiny antennas embedded in the floor broadcast the taped discussions.

Explanation by an expert: John Hand of the Gallery's Education Department describes artist, painting, and period to visitors at the 25th-anniversary exhibition of French works of art. He points out the great sense of light and color in Pierre Bonnard's "Nude in an Interior," painted about 1935. The Gallery conducts general tours every day of the week, as well as special tours for children and large organizations.

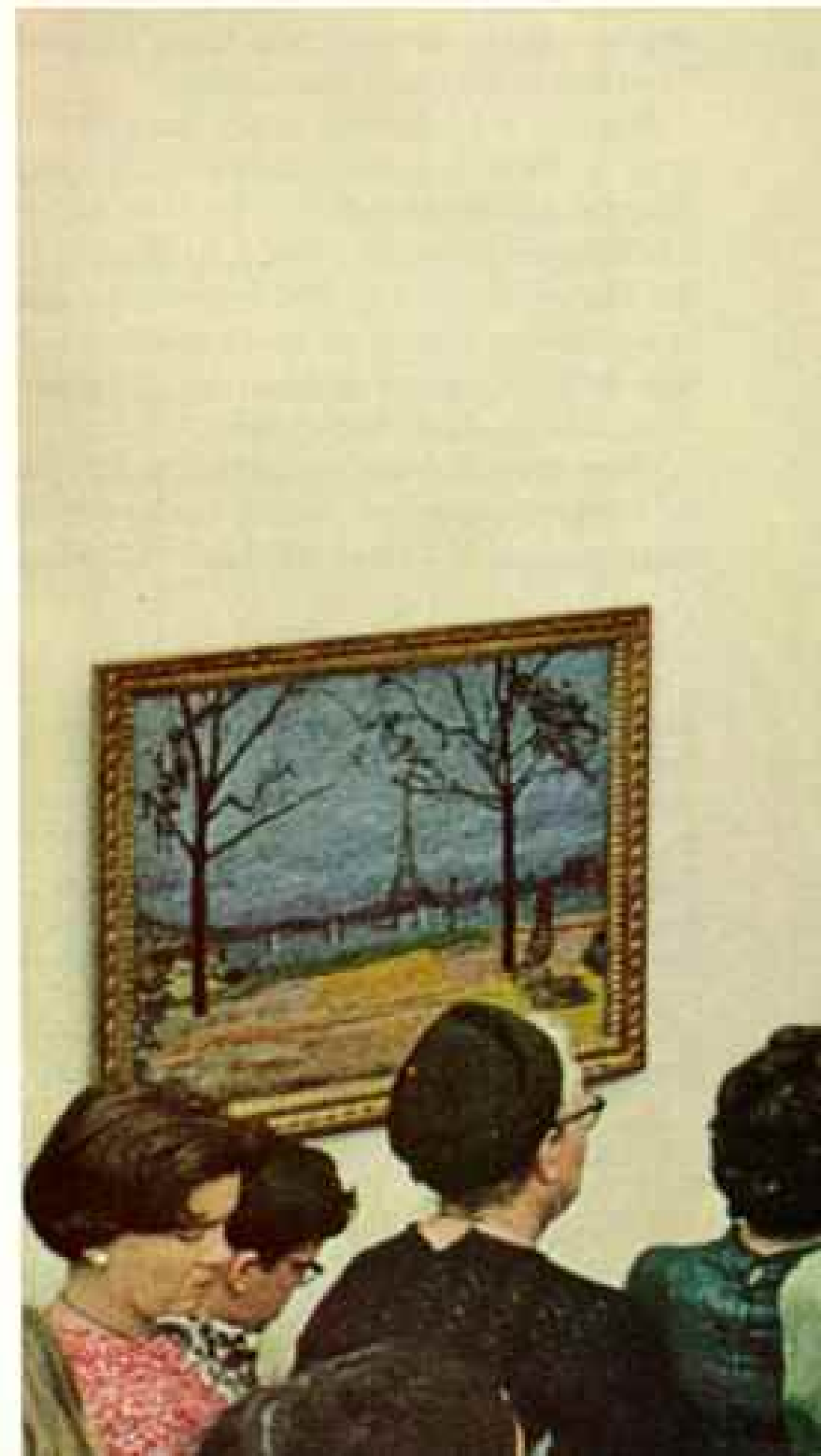

Among the Gallery's services, none rival in scope or effectiveness those offered by the Education Department. Within the building, we have pioneered an electronic system—Lec-Tour—that enables individuals to take guided tours at their own convenience. Visitors rent a little radio device that picks up commentaries broadcast in the exhibit rooms (opposite).

Free leaflets available in approximately half our exhibit rooms provide information on the paintings displayed; eventually, they will be supplied throughout the Gallery. Visitors have helped themselves to 15,000,000 of these convenient, informative sheets. The truest measure of their value lies in the fact that virtually none have turned up in our trash.

Last year, 80,000 children took advantage of lecture tours carefully adapted to their varying age levels. Upon two weeks' notice, the Education Department will set up a tour for any group of 15 or more, and will even demonstrate painting techniques in our studios.

The Gallery's educational responsibilities do not end at its doors. We constantly seek new ways to extend our facilities across all 50 states. Merely for the price of postage, any

college, school, or club may obtain exhibitions of large reproductions, slide lectures, film strips, and motion pictures. A survey indicates that some 1,400,000 people used these extension services last year—nearly as many as visited the Gallery itself. Testifying to the broad appeal of this program, we number among our steadiest and most valued outlets both the Methodist Church and the Federal Penitentiary at Leavenworth.

Gallery Expands on All Fronts

The activities of the Gallery will doubtless expand in the years to come. Already we feel the pinch of diminishing space. Fortunately, with great foresight Mr. Mellon made his gift contingent upon the allocation to the National Gallery of a large adjacent tract of land. There, between the present edifice and the Capitol, will someday rise a second building, thus assuring the Gallery's future expansion.

The National Gallery—*your* National Gallery—symbolizes the American commitment to art. And what is art, after all, but a glowing summation of the human spirit? It lights our past. It will light our future. * * *



ANDREW MELLON'S SON TELLS OF THE JOY
HE AND HIS SISTER FIND IN THEIR COLLECTIONS
OF 19TH- AND 20TH-CENTURY FRENCH PAINTING

In Quest of Beauty

PROBABLY NO TWO PEOPLE come to a love of art by precisely the same route. My own affection for paintings was born during my childhood in my family's house in Pittsburgh. In that pre-smoke-control era, soot hung like a pall over the entire city, and I remember our house as being very gloomy indeed, in atmosphere and decoration.

But on the walls, like windows into a world of eternal brightness, glowed the pictures collected by my father, Andrew Mellon. Faces painted by Gainsborough, Reynolds, and Romney smiled down at me from backgrounds of well-tended English manors.

With maturity, I followed my father's precedent and also became a collector of art. Some commentators have characterized collecting as a disease—a kind of acute acquisitiveness. I disagree. To my mind, it is merely an adult extension of the pleasure felt by every child in searching out, enjoying, and conserving those objects that he considers odd, rare, or beautiful.

Possibly because of the luminous English paintings that brightened my childhood, my early activities as a collector focused upon the art and books of the British Isles. Gradually, my wife Bunny drew my interest toward the French Impressionists.

She and I—and I think I can also speak for my sister, Ailsa Mellon Bruce—have always loved the out-of-doors. Perhaps this explains our affinity for the Impressionists. For never before or since in the unfolding pageant of art have painters so brilliantly captured the poetry of the countryside.

To the complacent art salons of the late 19th century, the Impressionists brought a revolution, of both vision and technique, that was like a new wind blowing through musty galleries. Subjects from everyday life replaced gods and heroes. The artist applied his pigments in fragmented dabs so that the eye of the beholder mixed the colors. Most of all, light in all its nuances was suffused with a lyric quality.

Last year, when the National Gallery exhibited 248 works from my sister's and my own collections as part of its 25th-anniversary celebration, a critic characterized the assemblage as "quiet." So it was. In the fullest sense, these paintings reflect our personal tastes. They are paintings that we love, paintings that we like to live with and look at constantly. My sister, my wife, and I regard it as a distinct privilege to share them with those who visited the National Gallery, and with the wider public that will see this selection.

Paul Mellon

Monet Purest of the Impressionists, Claude Monet (1840-1926) captured the essence of light and air. A stiff breeze swirls through "Woman With a Parasol—Madame Monet and Her Son," painted between 1875 and 1878. "His pictures always were too draughty for me!" commented fellow artist Edgar Degas. "If it had been any worse, I should have had to turn up my coat collar."







Cassatt Daughter of wealthy American parents, Mary Cassatt (1844-1926) went to Europe at 23 and later settled in Paris to pursue a career in art. She joined the Impressionist group at the invitation of Degas, who could not believe that a woman could draw so well. Miss Cassatt avoided the posed portrait and strove for naturalness of expression and attitude, as shown in her "Child in a Straw Hat" (about 1886) and "Little Girl in a Blue Armchair" (1878-79), at right. Though she never married, she concentrated on painting mothers and children, remarking to a friend near the end of her life, "After all, woman's vocation . . . is to bear children."

Degas Master of the fleeting moment, Edgar Degas (1834-1917) watched the bustling life backstage at the ballet until an accidental grouping captured his fancy (upper right). Unlike most of the Impressionists, who insisted on painting from life, Degas relied on quick sketches and his memory of posture, light, and color, and painted later at his studio. In "The Dance Lesson," executed between 1880 and 1885, young girls collapse after a practice session, yet retain a sense of grace.





ALL FROM COLLECTION OF MR. AND MRS. PHIL BELLIN © NATIONAL GEOGRAPHIC SOCIETY



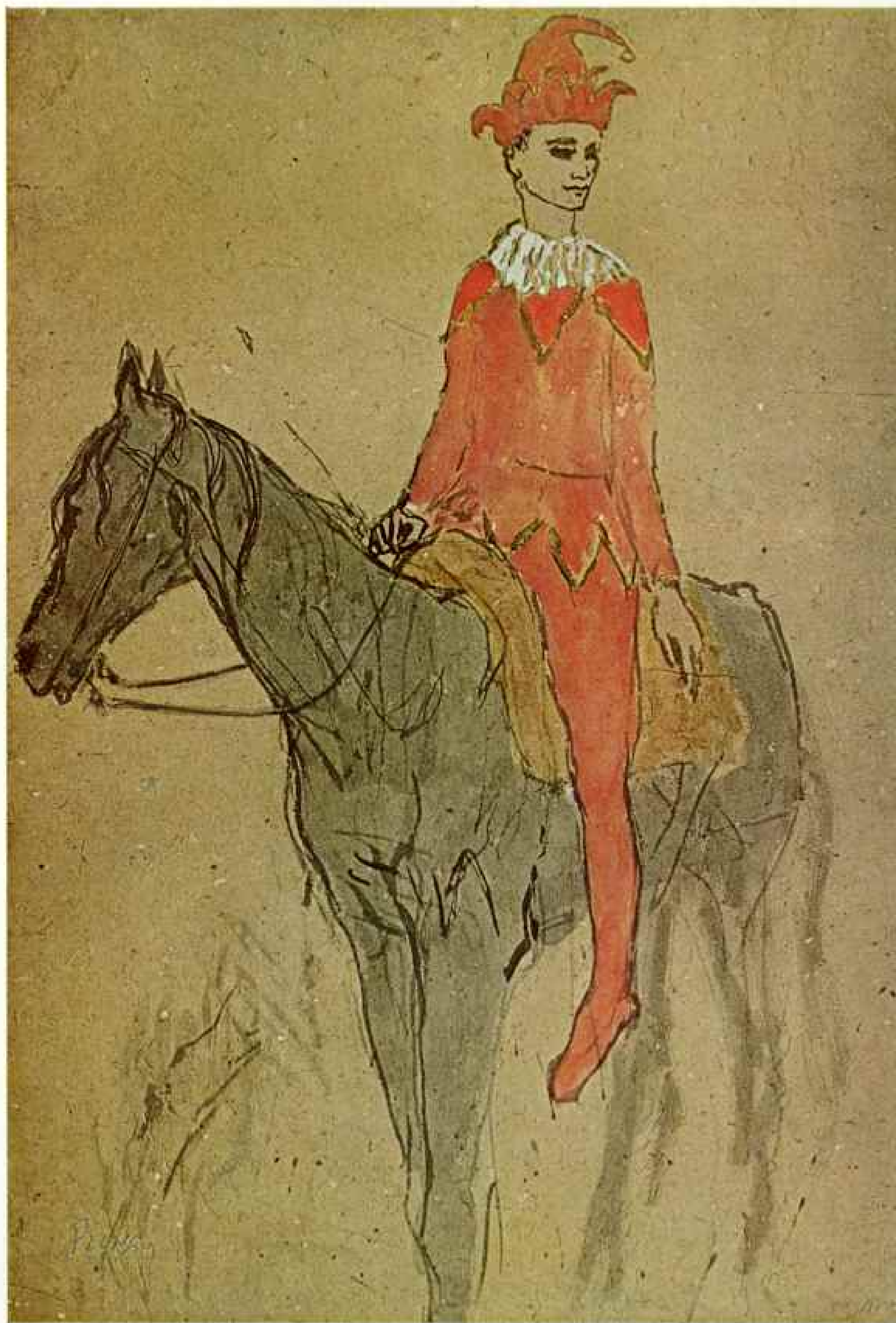

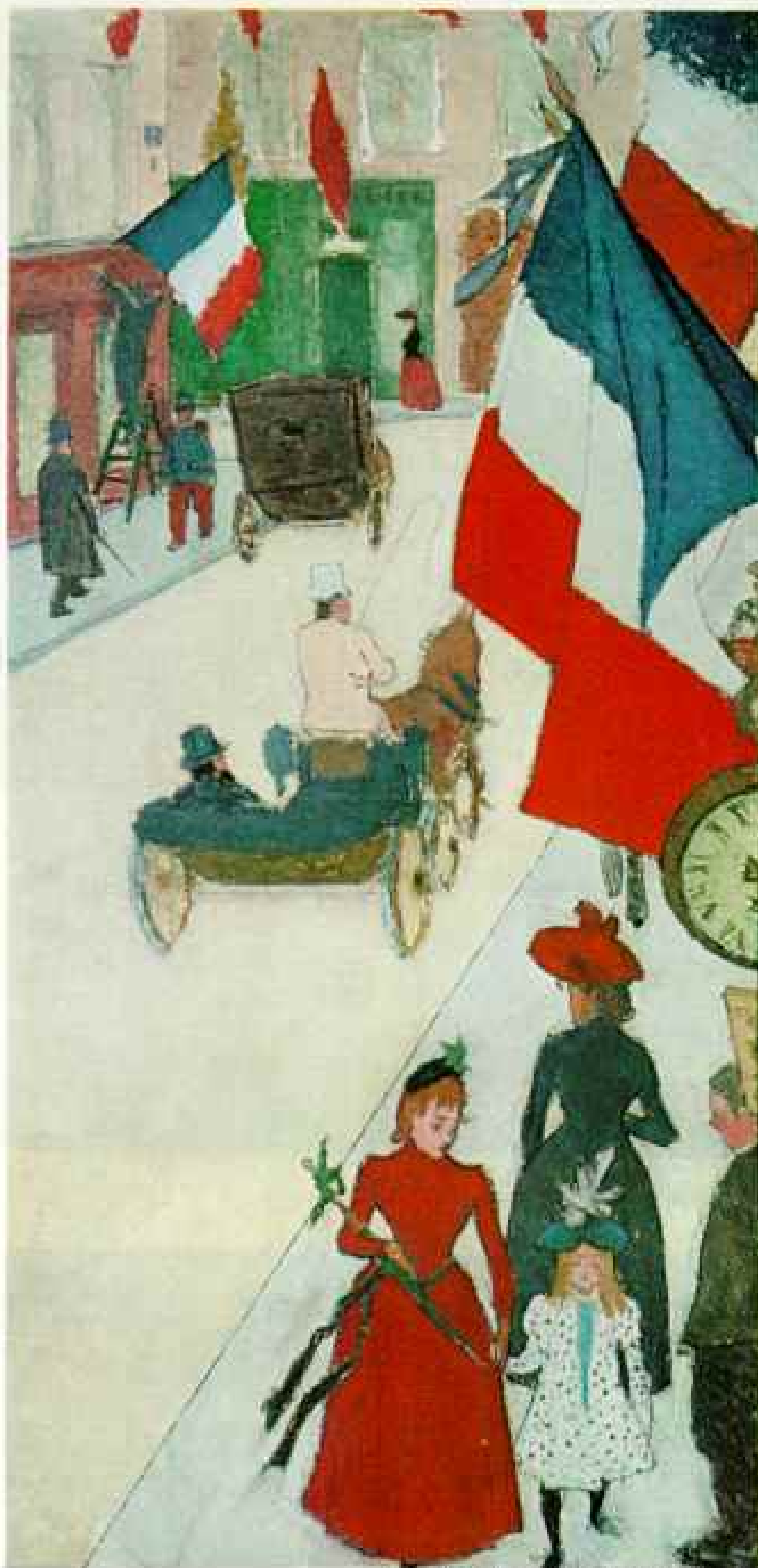

COLLECTION OF MR. AND MRS. PAUL MELLON © N.S.G.

Bonnard An early work of Pierre Bonnard (1867-1947), "Paris, Rue de Parme on Bastille Day" (1890) reflects his fascination with the flat style of Japanese prints. Seldom satisfied, Bonnard once persuaded a friend to divert a museum guard so that he might surreptitiously retouch one of his paintings.

Picasso "He was born making drawings," wrote author Gertrude Stein of Pablo Picasso (1881-). Inspired by clowns of Paris's Cirque Médrano, the Spanish artist painted "Harlequin on Horseback" in 1904.





ALL ILLUSTRATIONS NEXT TWO PAGES FROM COLLECTION OF MR. AND MRS. PAUL MELLON © N.A.E.

Rousseau Although he falsely claimed to have tramped the Mexican jungles, Henri Rousseau (1844-1910) often drew upon frequent visits to the Paris botanical gardens for his paintings. Common plants and flowers zoom to enormous heights in "Tropical Landscape—An American Indian Struggling With an Ape" (1910).

Lautrec "Red-Headed Woman in the Garden of Monsieur Forest, Montmartre" (1889), by Henri de Toulouse-Lautrec (1864-1901), is one of his rare studies in the play of natural light and shadow. The artist, deformed as a youth, more often caricatured entertainers and habitués of cabarets.

Bazille He gave the world more than his own art. Son of wealthy parents, Frédéric Bazille (1841-1870) supported Monet and Renoir when they had no money for food or paints. One of his last and finest works, "Negro Girl With Peonies" was painted just before his death in the Franco-Prussian War.

Seurat ►

Thousands and thousands of tiny dots of pure color fuse in the eye of the beholder, and the serene paintings of Georges Seurat (1859-1891) come to life. He rebelled against the "disorderly" strokes of the Impressionists and meticulously applied his spots of color according to the science of optics.

Because of this time-consuming technique, Seurat produced only a few major canvases during his brief life. "Lighthouse at Honfleur" (1886), recently acquired by Mr. Mellon, was probably the last remaining large Seurat available to a private collector.

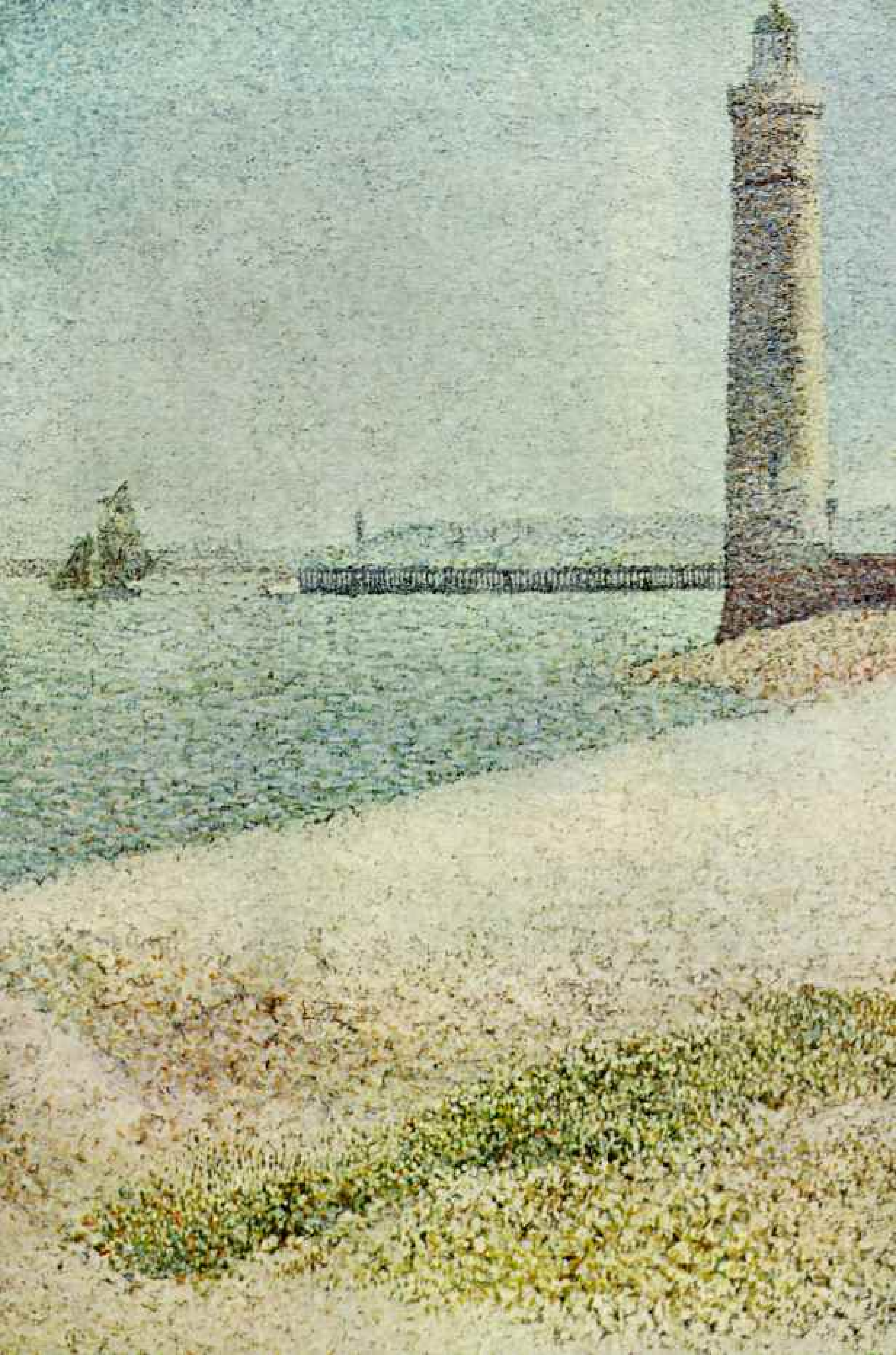





COLLECTION OF MR. AND MRS. PAUL NELSON (LEFT AND RIGHT) © N.S.A.

Cézanne Unlike the Impressionists, whose forms seem diffused in light, Paul Cézanne (1839-1906) created solidity and depth in contrasting colors and shifting planes. He painted "Boy in a Red Waistcoat" between 1893 and 1895.

Morisot Woman of many roles—artist, wife, mother—Berthe Morisot (1841-1895) also served as hostess for the Impressionist group. With delicate tone and line, she included her sister in "The Harbor at Lorient" (1869).

Van Gogh The young Dutch painter Vincent van Gogh (1853-1890) brightened one of his somber early works with the rainbow hues of tulips in "Flower Beds in Holland" (about 1883). His later paintings blazed with color.

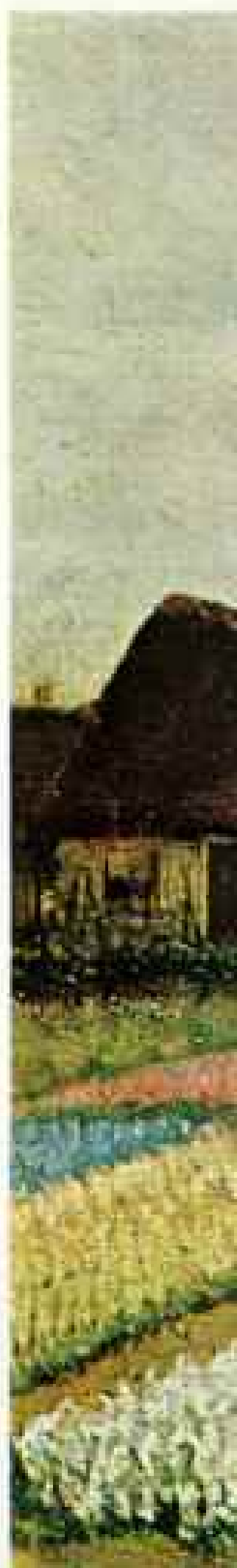
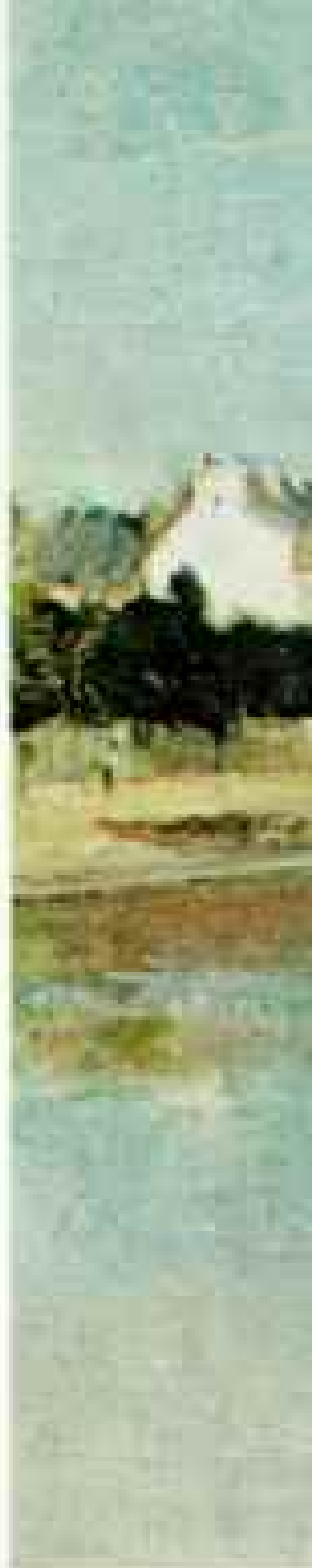



COLLECTION OF MRS. MELLER BRICE © N.Y.C.





Gauguin A successful stockbroker, Paul Gauguin (1848-1903) first painted only on Sundays. Then, at 35, he decided to devote his life to art. On his second visit to Brittany in 1888 he painted "Breton Girls Dancing—Pont-Aven." Van Gogh's brother Theo, then agent for Gauguin, found a buyer for the work if the artist would repaint the hand at far left. Gauguin did. Believing he would find



COLLECTIONS OF MR. AND MRS. PAUL MELLON (ABOVE) AND MRS. MELLON BRUCE © M.G.A.

peace and inspiration in the tropics. Gauguin sailed to Tahiti, where he developed his bold, colorful style. Destitute, tormented, and ravaged with disease, he died in the South Seas in 1903. He left on his easel a Breton snow scene.



Manet One of the first of the Impressionists, Edouard Manet (1832-1883) drew critics' fire for painting contemporary life with a natural touch instead of in a classical, idealized manner. They also said he could not paint—yet with consummate skill of brush and knowledge of color harmony he created "Flowers in a Crystal Vase" (1882).



Renoir With a few deft strokes, Auguste Renoir (1841-1919) painted "Head of a Dog" about 1870. "Give me an apple tree in a suburban garden," he said. "I haven't the slightest need of Niagara Falls."

Squids

JET-POWERED TORPEDOES OF THE DEEP

By GILBERT L. VOSS, Ph.D.

Institute of Marine Science, University of Miami

*Illustrations by National Geographic
photographer ROBERT F. SISSON*

SOMEONE SHOUTED, "Here they come!" into the night, and photographer Bob Sisson, dangling from a crane in a bosun's chair 15 feet above the Gulf of Guinea and 40 feet off the ship's port side, aimed his camera toward the floodlit water.

Suddenly, out of the darkness beyond the patch of ocean illuminated by our research vessel *John Elliott*

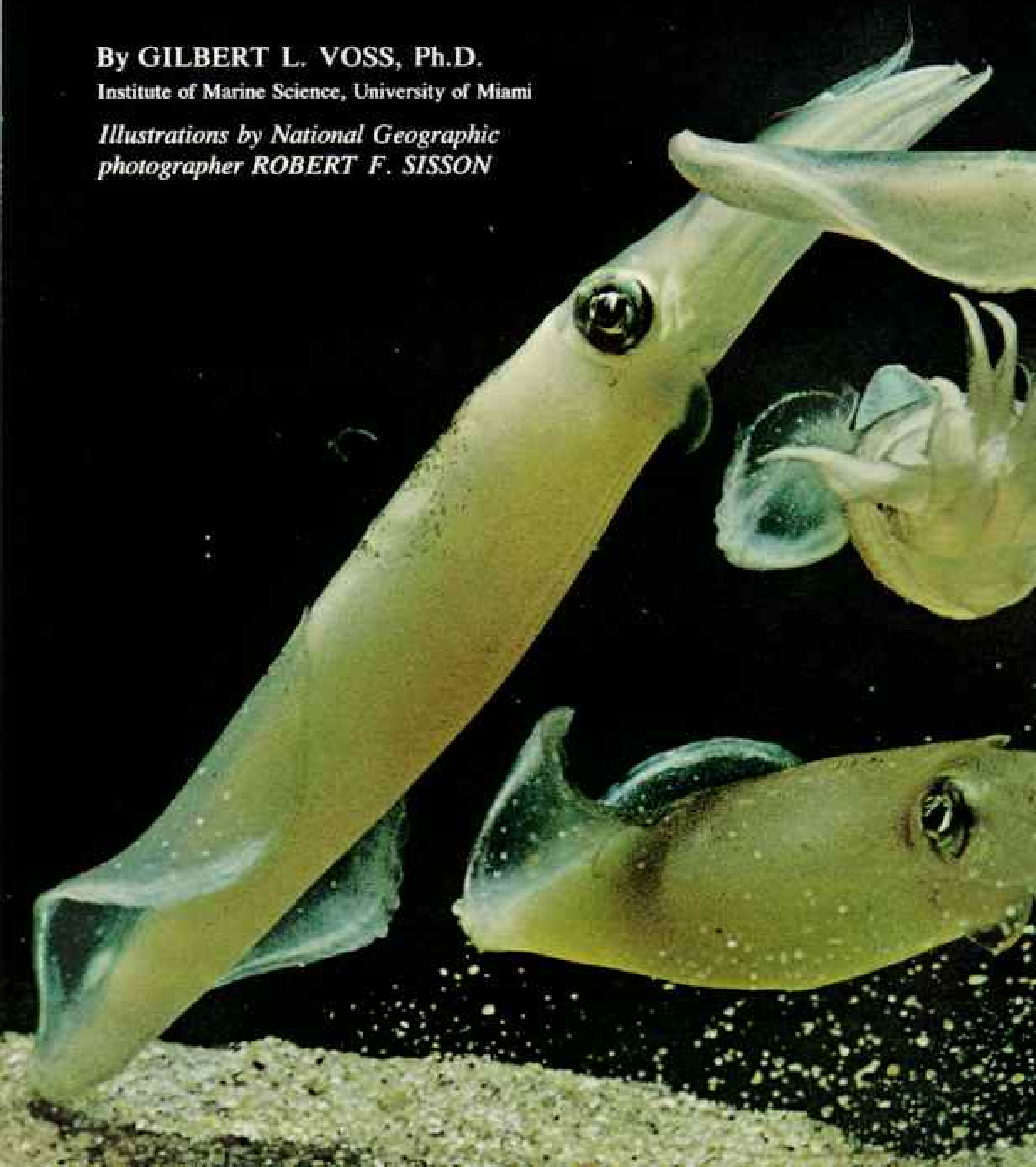

Pillsbury, several small greenish-yellow lights zipped into the glare. As they came closer, I could see that each oval glow marked a large squid, about a foot and a half long, moving purposefully toward small flying fish feeding on plankton near the ship's hull.

They came in at an angle. One squid paused about two feet away from its prey, and in the tentacled

TRANSLUCENT AS PHANTOMS, squids jet through the darkness, shooting forward and backward, up and down. Marvelously equipped for survival, these strange creatures—as short as a minnow or as long as a whale—can spray clouds of ink, change color, and, in some varieties, blink myriad glowing lights.

COMMON ATLANTIC COAST SQUID, *Loligo pealei*,
3/4 LIFE-SIZE © NATIONAL GEOGRAPHIC SOCIETY



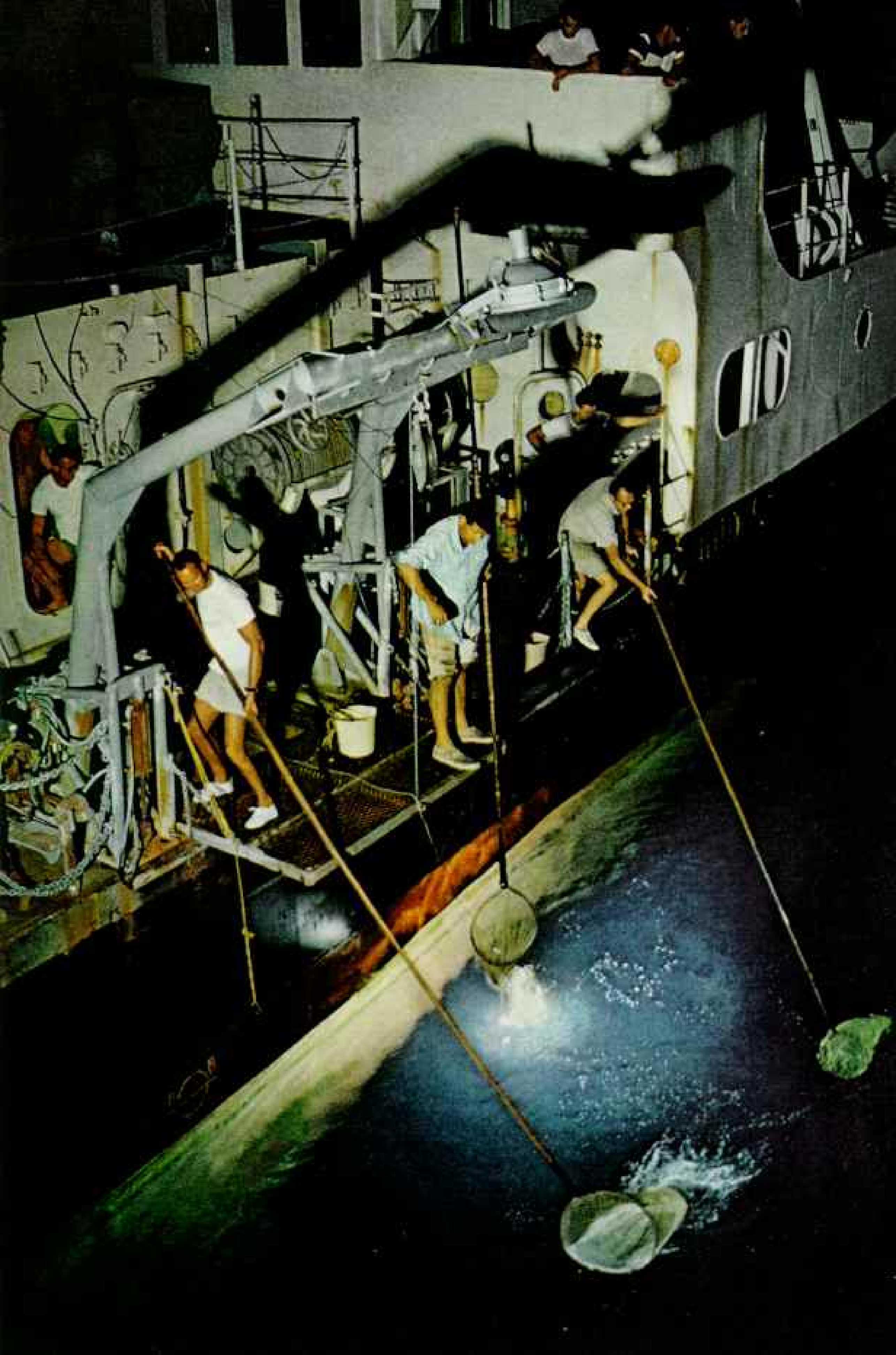

body a pale white light pulsed on and off several times. Luminescence cast a halo around the torpedo shape. In a flash, the squid darted down on the hapless fish, seized it, and shot off into the night.

Another squid was not so lucky. Clyde Roper and Dick Young, my graduate assistants at the Institute of Marine Science in Miami, stabbed the water with their long-handled dip nets. A moment later, amid shouts, laughter, and squirting ink, a squid was dumped unceremoniously into a pail of water on deck. Soon a dozen other captives poked around in various containers.

"These ought to make Sisson happy," I said. "Take them below to the photo tanks."

Virtuoso of the Invertebrates

The landsman, mentally populating the open oceans with sailfish, flying fish, porpoises, and whales, does not identify the squid as one of the glamor creatures of the sea. How mistaken he is! Few marine animals possess traits as fascinating, or flaunt such jewel-box beauty, as these translucent mollusks that, out of water, collapse into rubbery masses.

Quite apart from their talents of self-illumination and color change, these amazing relatives of the oyster and the clam have other attributes that strain credulity. The cephalopods, the class of mollusks containing the squids, octopuses, and cuttlefishes, include the swiftest swimmers in the sea, except perhaps for some game fishes, and exhibit behavior bordering on active intelligence.

Squids are powered with instant reverse

thrust: By changing the attitude of their water-ejecting nozzles, they can move backward or forward without turning. (Their usual direction of movement is backward.) Giant nerve fibers give them dazzling quick-start speed for capturing prey or evading enemies.

As a carnivorous predator, the squid needs keen vision. Its eye bears remarkable similarity to man's; for certain functions, in fact, it is better. Some squids have one eye several times larger than the other; each appears to be adapted to a different light intensity.

Squids inhabit every ocean, and among larger creatures only the fishes exceed them in abundance. Humboldt squids, dying mysteriously off the coast of Chile, may strew their carcasses over a band a mile or two wide and several hundred miles long! Some midget species would not cover a dime; the giant squid, on the other hand, measures up to 60 feet overall, and perhaps even longer.

In our search for living specimens, we had worked the *Pillsbury* along the West African coast for days, our trawls sweeping the black depths nearly two miles beneath us. Each

The Author: From shipboard and at the University of Miami's world-renowned marine laboratory, Dr. Gilbert L. Voss (opposite, at right) has spent more than 15 years studying the children of the seas—the larval stages of oceanic life. At 49 he is also a recognized authority on squids and octopuses. The work of Dr. Voss and his Miami colleagues in biological oceanography has long been aided by research grants from the National Geographic Society. In June, 1956, the magazine published his "Solving Life Secrets of the Sailfish."

Light baits a trap. Author Voss and fellow scientists from Miami's Institute of Marine Science net squids attracted by a light slung off the research vessel *John Elliott Pillsbury*. The expedition surveyed the little-known marine life of Africa's Gulf of Guinea.

Squid homes in, tailfirst, to feed on fishes lured by the underwater light. Artful dodger of the sea, it uses split-second reactions to capture prey or evade a scientist's dip net.

EXTRAORDINARY (ILLUSTRATION) AND EXTRAORDINARY (© N.G.S.)



night we had flashed our lights on the surface, but without success. Now, at last, we had enough live squids for serious study.

Belowdecks, Sisson's three aquarium tanks glistened on the lab benches, the glass sides specially designed to admit ultraviolet light. As he set up his electronic ultraviolet flash—devised just for this job—Bob's face virtually glowed in anticipation.

Carefully we transferred the squids into the tanks. Everything seemed perfect. Varicolored lights pulsed from the squids' bodies. The captives shot around the tanks, propelling themselves with sudden jets of water.

"They're all yours," I told Bob and turned to leave. But as I laid my hand on the door-knob, he gave a yelp of dismay.

Without warning, every squid in the room had fired inky jets, showering Bob, his equip-

ment, and the bulkheads with brownish-black water. Hardly a squid was visible in the suddenly clouded tanks.

"What happened?" Bob asked as he set about cleaning up. "Most of the squids seemed to die in the middle of the explosion."

"That's one of the troubles with squids," I explained. "Octopuses can live almost indefinitely in tanks—great for behavior studies. But, even with the best of luck, squids seldom survive for more than a few days."

Prisoner Jumps From Cell to Cell

Squids are fast-moving, excitable creatures, unused to confinement. In captivity they dart about erratically, fatally injuring themselves and even suffocating in their own ink. Most just seem to die of shock.

I have seen many squids give a quick shiver

Living lantern of the midnight sea, a squid's biological light "turns on" under ultraviolet rays. Like many of his relatives, the "orange back" carries light organs—photophores—containing chemicals related to those that set fireflies aglow. Named for the patch of light behind his head, *Ommastrephes pteropus* can also shine with a network of whitish photophores embedded in his flesh. Scientists think the lights may keep schools together, attract prey, or frighten enemies. Fins near the end of the mantle aid in steering and balance.



and keel over dead almost immediately after capture. Later we learned to keep the big squids in running sea water for a few minutes until they quieted down, before transferring them to the tanks. Sisson reported some success in keeping his tanks free of ink by making the squids eject the murky brown liquid before he placed them in a clean container. "But the odd one," he said, "always had just one more squirt left."

We had other troubles. One night I had just put a large squid into the corner photo tank and left the lab, when Bob called me back. "Which tank did you put that squid into?" he asked.

"The corner one," I said. "Why?"

"Look at it now."

There was the corner tank, camera pointed at its side, floodlights shining into the water—empty. Beside it, swimming peacefully around in another tank and staring at us with large, unblinking eyes, was our subject.

Bob laughed. "Just as you went out, he decided he didn't like your tank, gave a quick shot with his jet, and leaped over into the other." Philosophically, Sisson moved his setup to the other tank.

On the night of the mass explosion, we examined one of the dying captives. In the lab, the whitish



LIOCRANCHIA 2 THREE LIFE-SIZES BY ROBERT F. SISSON © N.S.P.

Bug-eyed bubble, a baby squid carries internal organs encased in a thin transparent mantle. Loose-fitting to admit water, the mantle opens and closes behind the head. Liver of this *Liocranchia reinhardtii* shows red. Waving tentacles search for food. Eight arms will develop later.

391



LIOCRANCHIA © S.C.C.

Squid's-eye view of a squid's world: Through a lens dissected from a laboratory specimen, Robert Sisson photographed a *Loligo* swimming above two companions resting on the floor of a tank. The 1/8-inch lens, from an eye amazingly similar to man's, scans 180 degrees horizontally.

Maharaja of the deep, a sail squid wears lights like jewels. His several hundred photophores shine through color filters, and he can turn his lights off and on. Eyes in two sizes equip *Histioteuthis* for different situations, the author believes. He uses the eye on the right when feeding near the surface; the other, bulging four times bigger, lets in more light in the gloom of the depths.

HIISTIOTEUTHIS LIFE-SIZE BY PETER W. DAVID © S.C.C.



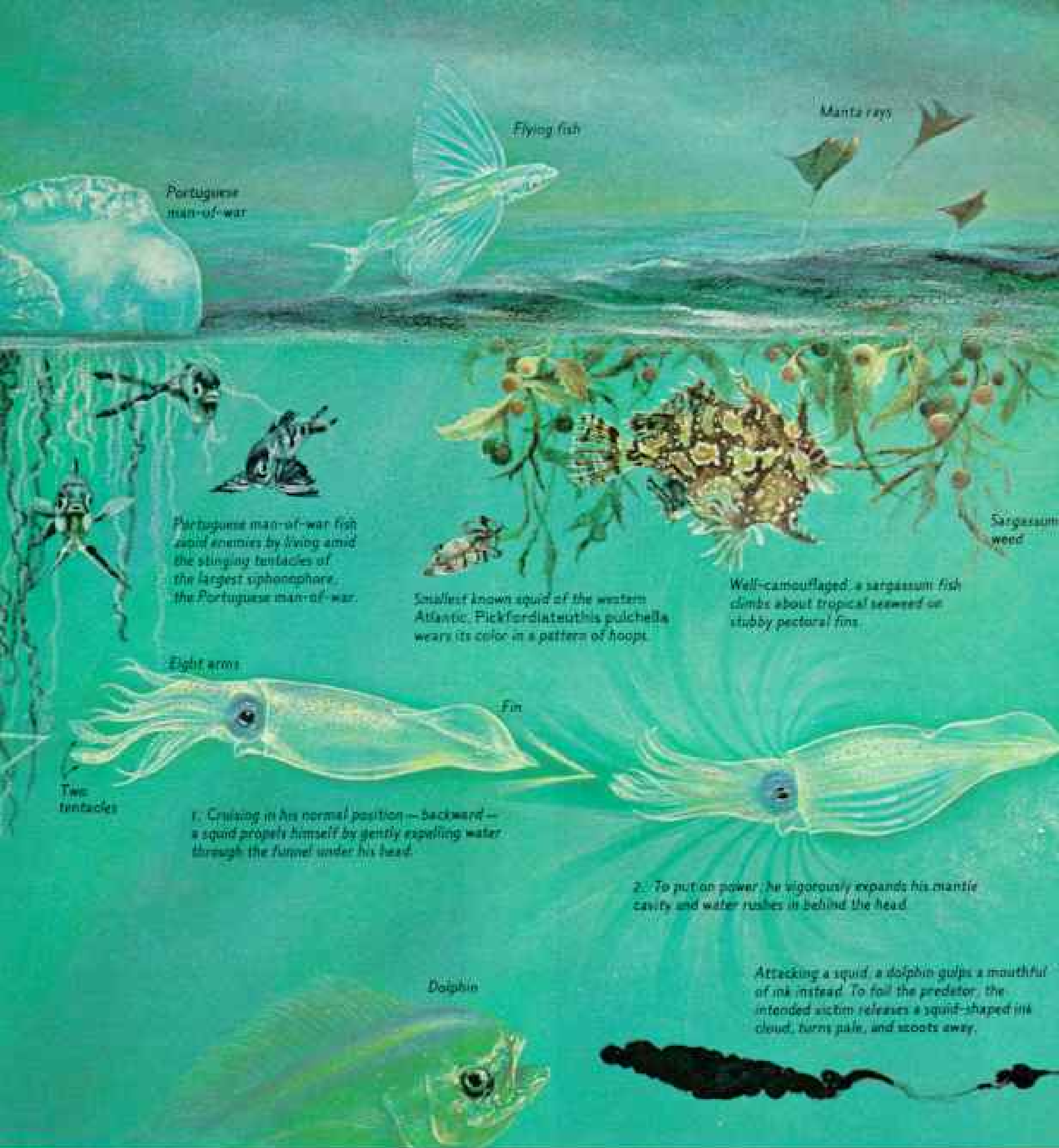

Portuguese man-of-war

Flying fish

Manta rays

Portuguese man-of-war fish avoid enemies by living amid the stinging tentacles of the largest siphonophore, the Portuguese man-of-war.

Smallest known squid of the western Atlantic, *Pickfordiateuthis pulchella* wears its color in a pattern of hoops.

Well-camouflaged, a sargassum fish climbs about tropical seaweed on stubby pectoral fins.

Sargassum weed

Eight arms

Fin

Two tentacles

1. Cruising in his normal position—backward—a squid propels himself by gently expelling water through the funnel under his head.

2. To put on power, he vigorously expands his mantle cavity and water rushes in behind the head.

Dolphin

Attacking a squid, a dolphin gulps a mouthful of ink instead. To foil the predator, the intended victim releases a squid-shaped ink cloud, turns pale, and scoots away.

Like iridescent darts, flying squids (*Onychoteuthis banksi*) zip past other creatures of tropic

ocean. The glowing oval spot near its head no longer glowed, but when we darkened the room and turned on the ultraviolet light, the spot again glimmered with an eerie greenish-yellow hue. As the animal died, the glow faded.

"But what about the flashes the squids made just before they grabbed the flying fish?" one of the crew members asked. "They seemed to come from all over the body."

In answer, Clyde Roper turned the lights on, slit open the squid, and pointed out the photophores, tiny spherules like pale grains of sand embedded in the creature's fleshy

mantle. They were invisible from the outside now, though in life the mantle of this squid is almost completely transparent.

"These organs are spread all through the belly, head, arms, and tentacles of the animal. They give off a whitish light. Now look at the difference between these photophores and the orange spot on the back."

Clyde slit the two-inch-long oval, and a mass of ricelike kernels poured out. They produce the strong yellow-orange glow that gives this swift Atlantic squid, *Ommastrephes pteropus*, its common name of "orange back."

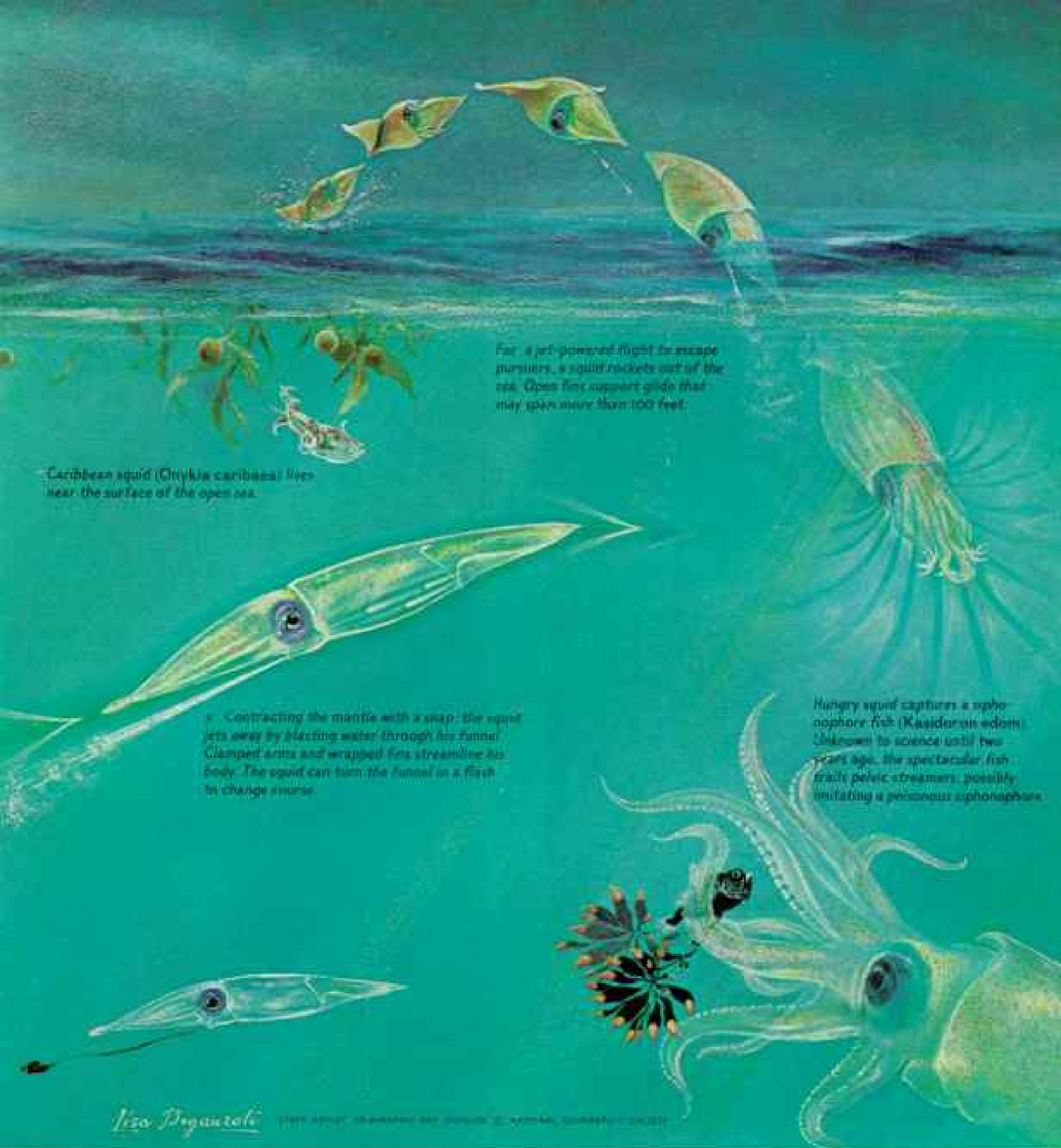

For a jet-powered flight to escape pursuers, a squid rockets out of the sea. Open fins support glides that may span more than 100 feet.

Caribbean squid (*Onychoteuthis caribbaea*) lives near the surface of the open sea.

Contracting the mantle with a snap, the squid jets away by blasting water through its funnel. Clamped arms and wrapped fins streamline its body. The squid can turn the funnel in a flash to change course.

Hungry squid captures a siphonophore fish (*Kasidoteuthis edoensis*). Unknown to science until two years ago, the spectacular fish trails pelvic streamers, possibly imitating a poisonous siphonophore.

seas. Turning the jetlike funnel under the head, squids can move quickly in any direction.

Most squids of the mid-depths have similar light organs. The light is caused by a chemical reaction similar to that which creates the biological "cold light" of fireflies.* In fact, the Japanese firefly squid flashes periodically, as does the insect.

Lanterns Flash in Many Hues

Some of the squids' light organs are gigantic, as large as a fifty-cent piece; others are mere pinpoints. Some species carry these light-producing organs on the outside of their bodies; in others they are buried within the

body cavity. Some grow them on the ink sac, on the lower surface of the eyes, or on the tips of the arms and tentacles.

One night aboard the *Pillsbury* we brought up five or six two-inch fire squids, of a species new to science. I placed one of the tiny live animals under the microscope and slowly focused down on it. To my amazement I found myself looking at a host of tiny glittering blue-green lights of almost ethereal beauty, like

"Light-giving insects were described in NATIONAL GEOGRAPHIC in "Wing-borne Lamps of the Summer Night," by Paul A. Zahl, July, 1961, and "Torchbearers of the Twilight," by Frederick G. Vosburgh, May, 1951.



CUTTLEFISHES BY ROBERT F. SISSON © N.E.L.

Firehose stream of inky water hurtles from a fighting squid (right) as a fisherman off Viña del Mar, Chile, gaffs his catch. Helpless out of water, the 60-pound animal comes aboard (above).

Making these pictures, photographer Sisson became the target of another Humboldt squid that momentarily blinded him with a jet of ink. "Fortunately, it stung even less than the salt water I used to clean my eyes," he reports, "but the stains are still on my work clothes." Cuttlefish ink, or sepia, taken from a cousin of the squids, was used as an artists' pigment long before today's India ink.

The Humboldt squid, *Dosidicus gigas*, spews ink with muscles activated by giant nerve fibers almost 100 times the thickness of man's. Studying squid nerves, scientists have enlarged their knowledge of how the human nervous system works.





distant stars on a tropic night. But even as I watched, the lights began to fade one by one, until only a series of clear glasslike beads remained. Seldom has the effect of death struck home to me so strongly.

In some squids the light organs are simple structures consisting only of a lens, the light-producing tissue, and a reflector. In other species, such as the deepwater sail squids that have a web between their arms, the light organs are equipped with diaphragms, focusing mechanisms, and even color filters that can expand over them (page 391). Certain squids, such as the fire squid *Lycoteuthis*, can produce several colors of light: white, blue, yellow, and pink.

Lights May Lure Prey to Hooks

No one understands the function of these light organs. Most biologists believe that in the darkness of the ocean depths they aid in keeping the squids together in schools. Others think they attract planktonic animals within reach of the tentacles. They may also serve to frighten away predators, attract mates, or light the way like lanterns.

In *Chiroteuthis*, a slender, rather feeble deepwater swimmer, I think the lights on the ends of the tentacles are for catching planktonic animals. The tentacles are mere threads many times the length of the squid, with a cluster of small, long-stalked hooks near each glowing end. Probably the squid lies motionless in the sea, dangling its tentacles far below. When plankton surround the light, they are jigged by the cluster of hooks and drawn slowly up to the squid's mouth.

The bobtailed squids use another kind of biological light, produced by luminescent bacteria. These glowing one-celled organisms are contained in a small gland near the squid's ink sac. When a fish chases the squid, the fugitive shoots out a cloud of ink. Plain ink

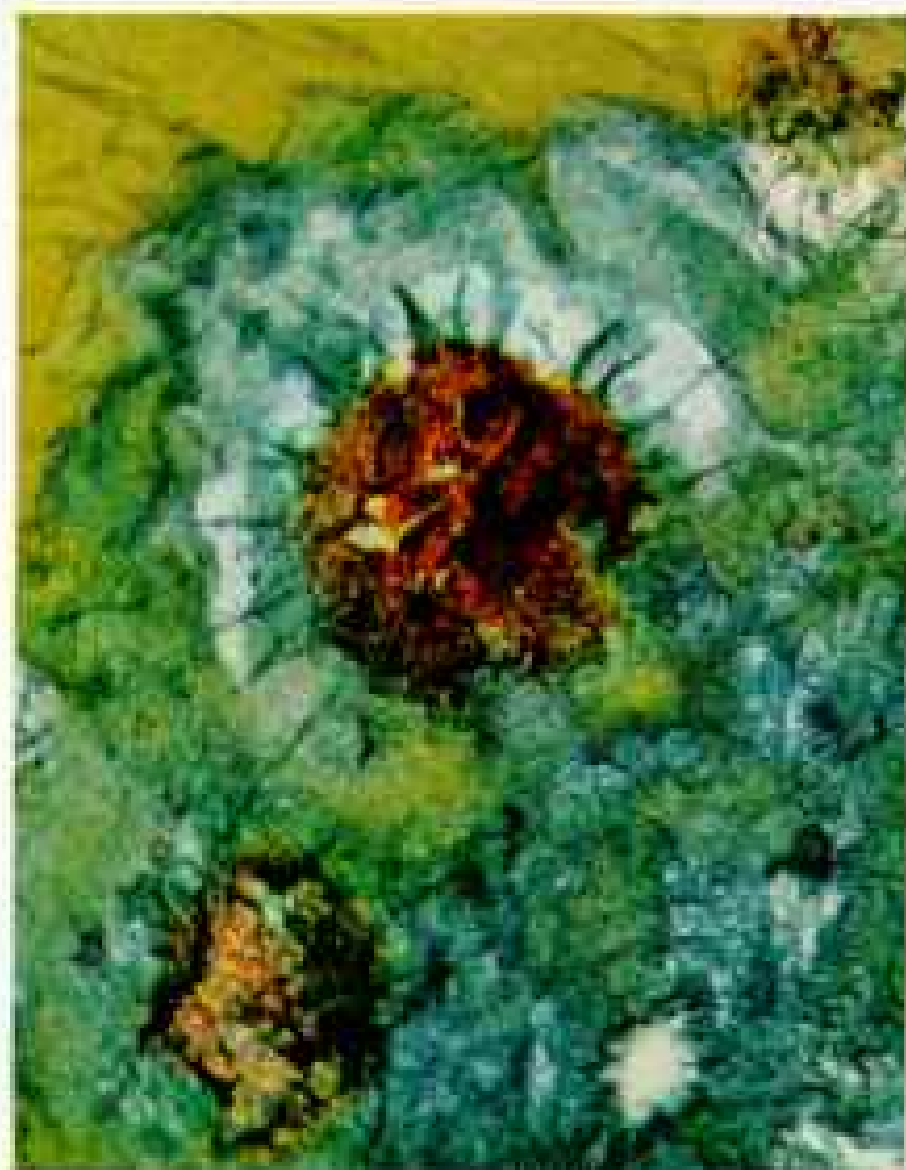

CHROMATOPHORE © N.C.S.

Coat of many colors covers a squid's body; each spot marks a chromatophore, an elastic sac of pigment. Scientists have found brown, black, red, blue, yellow, and orange sacs, but no squid seems to carry more than three colors. Nevertheless, by opening and closing different sacs, the squid can create a wide variety of hues.

To reveal its complex structure, a single chromatophore (above) has been sliced onion-skin thin, stained, and magnified 20 times. When the squid's brain sends it a message to change color, the impulse travels along nerves to radial muscles, here showing as blue lines surrounding the sac. The muscles open the sac, revealing a pool of pigment. When the impulse is turned off, muscles relax and the sac closes.

Colors pulse gently as *Doryteuthis plei* (twice life-size at right) cruises with funnel spurting slowly—a view from below. Swimming keels on the outer arms stabilize the squid as he jets through the deep. Rows of suckers line arms and tentacles.

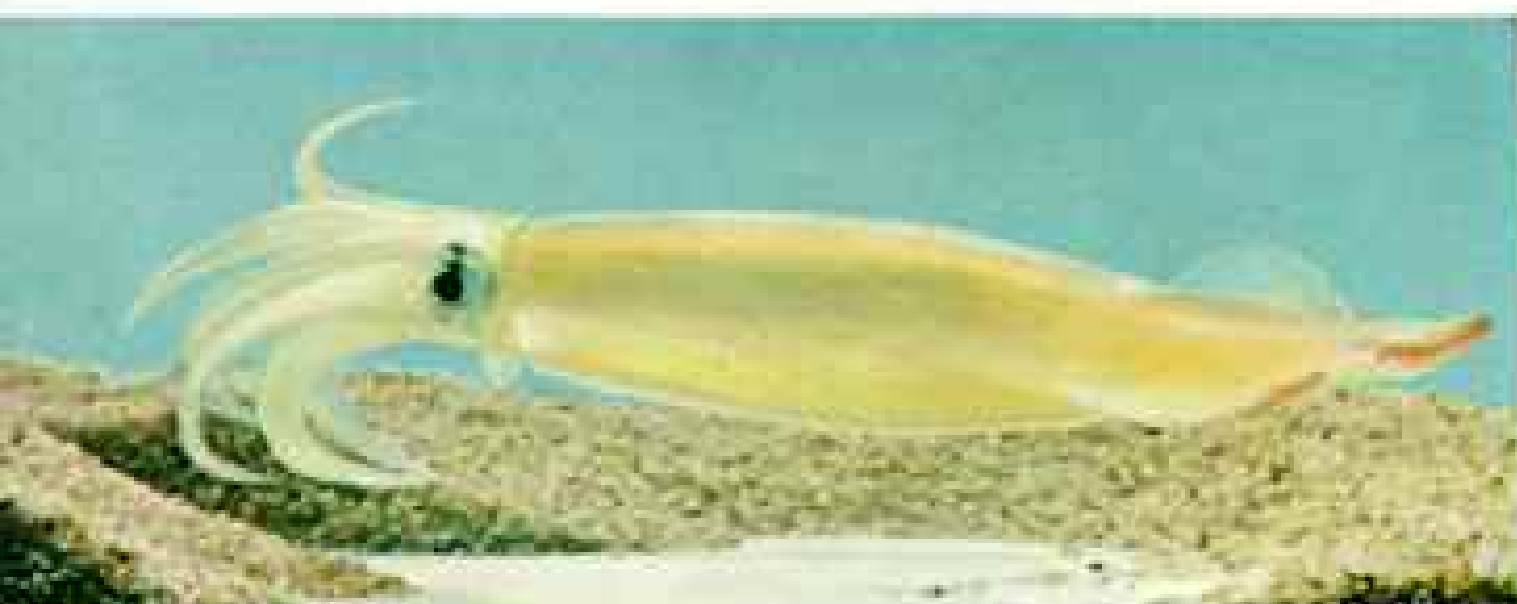

DORYTEUTHIS PLEI LIFE-SIZE



Quick-change artist, a short-finned squid (*Illex illecebrosus*) hovers near the sand in a silvery coat. Disturbed, he opens many chromatophores, flushing a wave of reddish brown over his entire body in less than a second (below).

In varied palette and speed of change, the squid far surpasses the chameleon. He can switch hue swiftly to merge with new surroundings, hide his flight, court a mate, or hunt prey.





With fleeting embrace, squid couples assure life for the next generation. This is the first color photograph ever published to show the squid's two mating positions. Aristotle about 330 B.C. wrote that squids "unite at the mouth by an interlacing of their tentacles"—and the upper pair proves the accuracy of his observation. With a specially adapted arm, the male *Loligo pealei* at right shifts sperm packets from within his body to an area under the female's mouth. In the other posture, below, the arms of a male encircle a female from her left side, making the transfer to within her mantle. An accompanying glue holds the sperm in the female until she spawns,

would be useless in the dark depths, but this cephalopod adds a shot of luminescent bacteria, and the ink glows weirdly. While the fish attacks the glowing cloud, the squid turns off all its lights and darts away.

Squids are normally so high-strung, and die so soon after capture, that I have tried to study them as much as possible in the field—on shipboard at sites of capture. But detailed work with preserved specimens also has been accomplished in the laboratories of my home base, the Institute of Marine Science at Miami. Both phases of our work have been supported generously by the National Geographic Society.

Not much is known about the chemical composition of squid ink. The color varies from black to light brown, and Bob Sisson can testify to its staining qualities. A suspension of

complex organic compounds, it is related to the pigments in the hair and skin of man.

Most writers liken the ink of cephalopods to a smoke screen, ejected as a cover for the escaping squid or octopus. Actually, this is not the whole story. An endangered squid will usually shoot out a cigar-shaped cloud of ink, approximately its own size. The ink coagulates in the water, forming a pseudomorph, or false shape. Simultaneously, the squid contracts all its chromatophores, becomes transparent or neutral-colored, and darts off to one side, frustrating its pursuer with a mouthful of inky water.

Artists have used the ink, or sepia—particularly that of the Old World cuttlefish—for at least 2,000 years; it was the forerunner of today's India ink. In 1817, Georges Cuvier used cephalopod ink to draw the illustrations



FOUNDAZIONE LIFE SIZE © 1984

moments or even days later, then the sperm fertilizes the eggs. During a ten-day vigil at Woods Hole Marine Biological Laboratory in Massachusetts, veteran staff man Robert F. Sisson captured the unusual photographs of the breeding cycle of *Loligo* on these and the following four pages.

for his classic anatomy of the Mollusca. Dried in blocks, the ink can be employed as a watercolor pigment. Its potency is long-lasting; good-quality writing ink has been prepared from the ink sacs of fossil cephalopods more than a million years old.

The quantity of ink yielded by a single animal is amazing. A few years ago, I obtained a freshly stranded blanket octopus. Slipping it into a three-gallon jar of alcohol, I accidentally broke the ink sac, and its contents began to seep out. In moments the entire jar was black.

Quickly, I removed the octopus and washed it thoroughly for about twenty minutes. With everything on and around me black, I put the animal into a fresh jar of alcohol—which in no time also became black.

Squids usually cruise slowly through the

water, propelled by fins along the sides of their mantles. But when they want to go somewhere in a hurry, they do what we do—they go by jet. Drawing water into the body chamber, or mantle cavity, they squirt it out through a tapered funnel, which can be turned forward, backward, or even sideways (painting, pages 392-3). A valve even prevents backfire!

While diving on the Florida reefs, I often watch squids of the species *Sepioteuthis sepioides* (page 410). They seem fearless and approach to within a foot or two, hovering in the water and rippling their narrow marginal fins just enough to hold themselves motionless. But if I reach out my hand to the squid, a flash of color passes over it, its mantle contracts, and it shoots away. The creatures are curious, though, and usually return within a short time, watching my every movement.

Much of the squid's speed originates in an unusual set of nerves in the upper surface of the mantle. These nerves, containing a system of giant fibers, are so highly developed that when the squid is threatened, a nerve impulse flashes to all parts of the mantle simultaneously, the muscles quickly contract in unison, and the animal jets safely away.

Giant Nerves Aid Medical Research

Scientists first began to study these nerve structures in the 1930's. And then came the big surprise. In some squids, such as *Loligo pealei*, common in the western Atlantic, and *Dosidicus gigas* of the eastern Pacific (pages 394-5), these fibers are tremendous—as much as 1/10 of an inch in diameter, as against 1/1000 of an inch for the largest in man. This is the most massive inner signal system known in the animal kingdom, and consequently the most easily studied.

Since that time, researchers have flocked to squid laboratories in North and South America and in Europe to work on squid nerves. Much present knowledge of the actions of human nerves, their physiology, biochemistry, and physics, we owe to the squid.

No one really knows how fast squids can swim, because their movements are so erratic. They are certainly among the swiftest animals in the oceans. Some can even shoot thirty or forty feet out of the water, gliding over the waves for more than a hundred feet. Not infrequently, they land on ships' decks.

Equipped with flashing lights, ink, and incredible speed, squids are well adapted to life in the sea, but these fantastic creatures seem especially blessed with survival mechanisms. One is an ability to change color so fast that



SPAWNING FEMALE *arranges a bouquet of egg strands as carefully as a matron fixes flowers. The squid ejects through her funnel buoyant pods of jelly, each encasing about a hundred eggs. Using arms as fingers, she fastens each strand into the cluster, called a mop. Other females add their egg pods to the communal nursery. Left unattended, embryos develop for about ten days until hatching begins.*

KODACHROME 1 1/2 TIMES LIFE-SIZE © N. G. S.



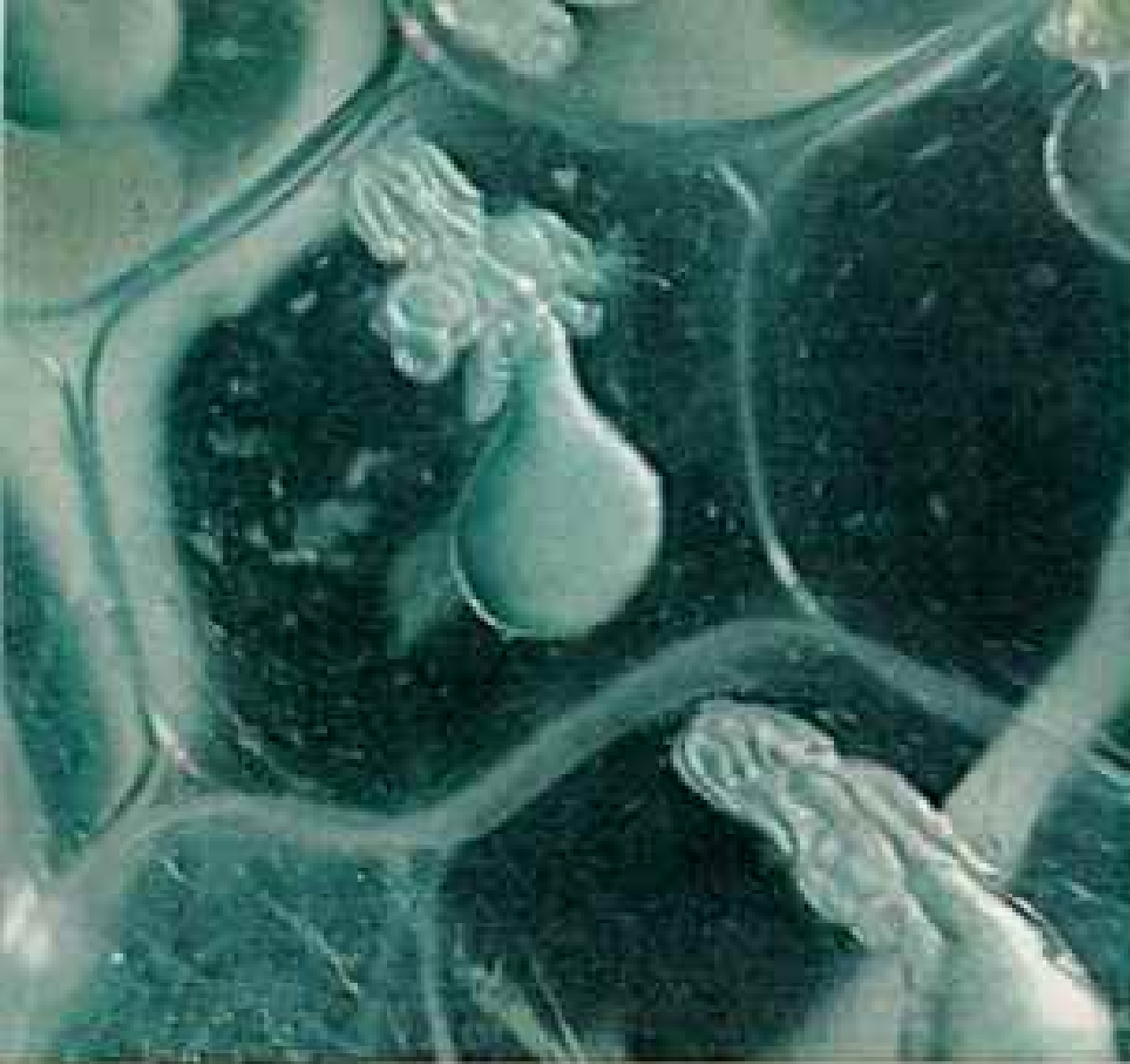

Pear-shaped yolk dwindles within a cellophane-like eggshell as an embryo feeds on it like a baby from a bottle. Eyes and head bulk large; mantle and fins grow more slowly. Arms, looking like leaf sprouts, reveal minute suckers.

An early hatcher (lower left) sheds his shell and darts past an embryo still imprisoned in the gelatinous strand. Ink sac, shining through the swimmer's mantle at left, looks like another eye.

Caged in a water drop, a hyperactive day-old squid (opposite) shows an early crop of chromatophores on his 1/8-inch-long body. With a Herculean squeeze, the irritated youngster (below) contracts his mantle to shoot a droplet of ink. At this age, he feeds on minute crustaceans and falls prey to almost anything larger than himself.

*(OPPOSITE) 20 TIMES AND (RIGHT) 20 TIMES LIFE-SIZE © R.A.Z.



When the sac opens, the color is exposed."

In addition to the chromatophores, squids have a deeper layer of prismatic cells which reflect the light all over the animal, painting it with a background wash of iridescent colors. Most of the squid's colors are used for camouflage, matching background of sky and ocean depths or inshore rock, shell, sand, or grass.

The cuttlefish, which differs from most squids by the hard calcareous shell within its body, is the real chameleon of the cephalopods. It is found only in European, Asian, and African waters, never in American.

Camouflage Masks Lurking Cuttlefishes

Cuttlefishes can match a background in fantastic fashion. Lying hidden in a clump of seaweed, they may wait for hours, wiggling the white tips of their arms like juicy worms, until a fish, shrimp, or crab comes within reach of their lightning-fast tentacles. Or they may lie on an open, pebble-strewn bottom, their skin mottled to reproduce the stones beneath them, almost invisible to their prey.

Unlike squids, they can withdraw their tentacles completely into pouches at the base of their arms. Larger cuttlefishes can then shoot out the tentacles a foot or more.

With all their adaptive organs, it is hardly

they put chameleons to shame. Myriad iridescent hues of red, purple, pink, blue, and yellow play across their bodies in continuous liquid display, like ripples across water.

"They look like living rainbows," one of my girl students exclaimed, watching the play of colors on a live classroom specimen.

"Look at it under the microscope," I suggested. Now the various hues were visible as separate dots—red, blue, orange, yellow—which opened into large irregular spots of pure, deep color, or suddenly contracted into pinpoints almost invisible even under the microscope. The squid produces shades by blending the basic colors (pages 396-7).

"But how do they work?" she asked.

"Each chromatophore is a little elastic sac containing pigment," I explained. "At rest the sac is closed, but when excited, the nervous system contracts muscle fibers, opening it.





surprising to find that the squids and octopuses have the nearest thing to a highly developed brain in the whole world of backboneless animals.

Cephalopods match their brain with a highly complex eye. Indeed, the eyes of most cephalopods are as efficient as the human eye, if not superior to it. They far excel the eyes of fishes. In fact, close resemblance of the cephalopod eye to the human eye is one of the most amazing phenomena in the animal kingdom.

The human eye has an eyelid. So has the squid's. We have a cornea. So has the squid. The human eye has an outer chamber, filled with aqueous humor, which contains a pupil that contracts or expands, controlling the amount of light admitted to the inner chamber. So has the squid's.

You and I have a lens hung between the outer and inner chambers to admit light, concentrate the rays entering the pupil, and project them on the retina. In man, muscles focus

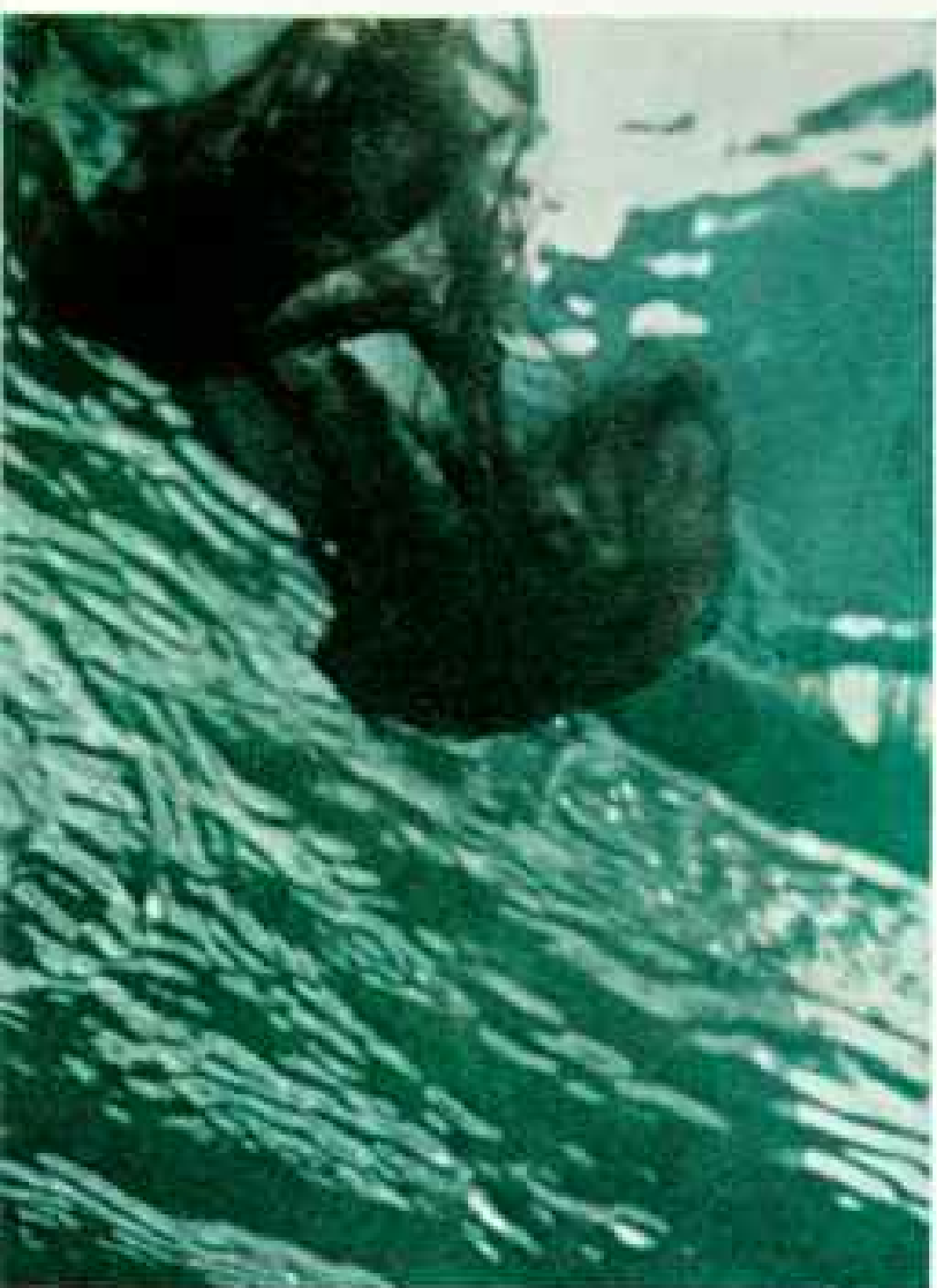

EXTRADORS AND KODACHROME (TOP) BY ROBERT F. WOOD © N.C.S.

Underwater drama: A pole-mounted camera held beneath the surface captures the death struggle of a short-finned squid dragged to its doom on a bright jigger. The desperate animal squirted the squid-shaped ink blob at right.

Ducking spray, the Newfoundland fisherman (upper left) furiously cranks in two squid-laden lines on drum-and-reel jigging equipment introduced by the Japanese.

Portuguese seaman in St. John's hoists a block of frozen squids. Thousands of tons annually sell for codfish bait.

the lens without changing its position. In the squid, it moves in and out much as in a camera, and even tilts so that the animal can look about without moving its eyeball.

Behind the lens (page 391), the curved inner wall of the great chamber of the eyeball is covered by the light-receptive retinal screen, which seems to contain the two major types of cells found in our own eyes: rods sensitive to low light levels and yielding only black-and-white images, and cones, which receive separate wavelengths and thus register color impressions. There are about 100,000 receptors per square millimeter in the normal squid eye, indicating that the squid, like man, is capable of seeing quite fine detail.

Here the similarity ends. For low-light vision, the cephalopod retina appears superior to that of humans. And, unlike man, the squid has no blind spot. Each squid eye, furthermore, sees independently. Only those peculiar squids whose eyes grow on stalks may possess binocular vision like man's.

Sail Squid Grows Odd-size Eyes

Eyes of squids are normally quite large—1/8 of an inch to a foot in diameter—and those that live deep in the sea, where little or no light filters down from the surface, generally have larger eyes than the shallower-dwelling animals. A great oddity, the sail squid (*Histioteuthis*), often sports one enormous Brobdingnagian eye and one smaller one (page 391). The whole head is lopsided, and I would suggest that the big eye functions in dim light and the small eye in brighter light.

When dissecting squids and cuttlefishes, I always look to see what they have last eaten. The stomach of an inshore squid I find filled with small marine worms. In most species I find pieces of legs, eyes, and light organs from an array of small shrimplike animals. Scales show that fish are eaten, and occasionally I find remains of other squids.

One large arrow squid, *Doryteuthis*, kept in our aquarium for several weeks, ate nothing but small fish. Seizing the live ration with his tentacles, he pulled it up to his beak and bit a V-shaped piece out of the nape of the neck, killing the fish. Gripping it in his arms, he tore the flesh from the skeleton in a matter of minutes.

The voraciousness of squids is phenomenal. When schooling, they will vie with each other for a squid-jigger, and often several will be brought up on the same lure. The Humboldt squid, which can reach 12 feet in length and is found abundantly along the west coast of South America, surfaces at night to feed and sometimes jumps out of the water in pursuit of prey. These oceanic wolves quickly leave nothing but skeletons of 600-pound marlin caught on long-line gear of commercial fishermen.

But marauding squids do not escape unscathed.

They are eaten by a host of enemies, from the sperm whale down to the common mackerel. Sperm whales live almost exclusively on squids, from giants more than 50 feet long to small sizes. Lips of most sperm whales, battle-scarred from encounters with the giant *Architeuthis* (opposite), show deep cuts and lacerations from the beaks of their prey. Their bodies sometimes bear scars the size of dinner plates, probably caused by suckers pulling in the whales' supple skin.

Smaller whales and porpoises also eat squids in vast numbers. One, the pothead or pilot whale, subsists almost exclusively in the North Atlantic on squids of the genus *Illex*.

A curious food cycle involves this squid and the mackerel. On the New England coast in autumn, squids come inshore in great shoals. One of their favorite foods is young mackerel. They dart into the mackerel schools, seize a young fish, take a single bite out of its neck, drop it, and dart off after another. But in the spring the adult mackerel get even. Then fully grown, they chase the young squids and devour them by the thousands.

Iberians Cook Squids in Their Own Ink

Man, of course, ranks among the squid's most formidable enemies. In many parts of the world, squids play an important economic role. They feed more millions than any other sea staple except the scale-bearing fishes.

Cuttlefish shells, or cuttlebones, from Japan and North and East Africa are exported world wide as a dietary supplement for cage birds. Japan uses great quantities of squids for food and fertilizer. In a good year, the United States takes only about 10,000 tons of squids, largely from California waters, whereas in 1963 Japan landed 650,000 tons of the species *Todarodes pacificus* alone.

Portugal and Spain both export canned squid, the major ingredient of that delicious squid-and-rice dish *calamares en su tinta*—squids in their own ink. In eastern Canada, particularly on the Island of Newfoundland, vast numbers of squids are frozen in large blocks and sold as codfish bait. Still, the supply appears inexhaustible. Certainly squids are among the commonest of all oceanic life.

Oddly enough, we know very little about the squids' life history. Most of our knowledge of their fantastic reproductive techniques has been learned from observing inshore species.

Squids and cuttlefishes, unlike some other mollusks, have separate sexes, and the eggs are relatively large, 1/16 of an inch to more than an inch in length. The males seek out the



© N. S. S.

Lethal beak equips the squid for combat in the deep. Powerful mandibles of a Humboldt squid, shown 1/2 life-size, can sever heavy wire. Lower one closes over the upper, unlike a parrot's. Rows of tiny teeth shred food as the tongue-like radula rams chunks down the throat.



1/2 LIFE-SIZE

Like charms on a bracelet, suckers dangle from the arm of a dead giant squid. Strong in life, the stalk and sucker work together, swiveling in any direction.



© TIMES LIFE-SIZE

Sucker of a Humboldt squid grasps like a vacuum cup when the stalk contracts. Teeth dig in for a firmer hold.

Awesome even in death, this giant squid measures 21½ feet from tip of tentacles to end of mantle. Such creatures—the world's largest invertebrates—still strike terror in seamen's hearts. Sailors have witnessed horrendous battles between squids and sperm whales, and writhing arms have beset fishermen's boats and life rafts, dragging men to their doom. A rare find, this young animal floated into Trinity Bay, Newfoundland, in October, 1965. Dissecting it, Dr. Frederick A. Aldrich, right, of Memorial University, St. John's, and the author, second from left, discovered giant nerve fibers, hitherto unknown in *Architeuthis*.

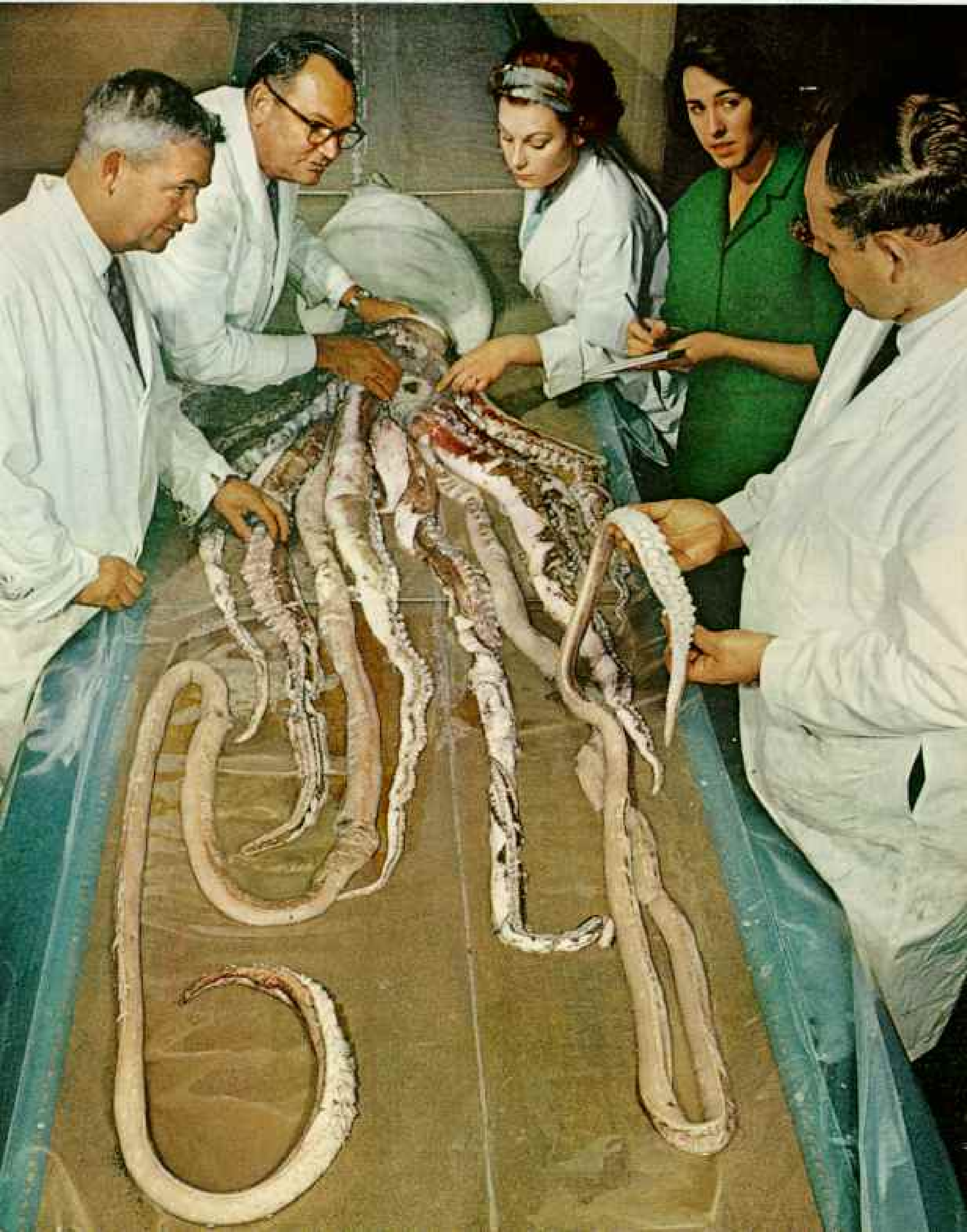

Shooting headfirst for supper, *Lolligo pealei* has seized a small fish with his tentacles and now draws it toward his beak with suckered arms. His companion rests, holding his funnel above the sand.

U.S. LIBRARY



females in spring and summer. After a brief courtship of arm waving and color display, the male twines his arms about the female (pages 398-9). With a specially adapted arm called a hectocotylus, he rapidly passes her a series of sperm packets, or spermatophores. These are cemented inside the female's mantle or under her mouth and held available for use when the eggs are spawned.

Squid spermatophores are among nature's most extraordinary reproductive mechanisms. Enclosed in a clear membrane, each spermatophore contains a sperm sac, cement for fastening the sac to the female, and a finely coiled tube terminating in a cap with an ejection thread.

When a male releases his spermatophores, their ejection threads are pulled and the coils spring open, rupturing the coverings. These turn inside out, exposing the cement for fastening the sperm sacs to the female.

The capsules often explode when put into a different medium. One day I was working in my laboratory with a new species of cranchiid squid, a male carrying ripe spermatophores. Working furiously, I set up my microscope,

lifted out the spermatophores, and dropped them into a preparing solution.

The telephone rang—a long-distance call. "May I call back?" I asked. The answer was an emphatic "No."

When I finally got free, all but one of those precious spermatophores had exploded into tangled, ruined masses. With trembling fingers I transferred that last fragile bit of protoplasm to the mounting fluid, dropped on the cover glass, and sighed with relief. From that day to this, I have been unable to remember anything of that phone conversation.

Flashing Light Overcomes Squids' Shyness

Once the spermatophores have been passed to the female, she lays her eggs. The shore squids lay them in jellylike strings, from three or four to more than a hundred eggs in each capsule. The sperm fertilizes the eggs while the capsules are still soft and penetrable, and the females attach them by threads to shells or stones on the bottom. Many females may join in making egg masses, called mops, several feet in diameter (pages 400-401).

Bob Sisson photographed the mating of the



common squid of the Atlantic coast, *Loligo pealei*, in the laboratory. The first time he fired his electronic flash, the animals retired to separate corners of the tank and gave him a nasty look. Subsequently, Sisson found that he could condition his subjects to a constantly flashing light, and after that the amorous squids didn't even look up as he photographed them.

The young of most shore squids and cuttlefishes are well developed when hatched and look much like their parents (pages 402-3). In many oceanic squids, however, the young hatch out as larvae. Some of them are weird creatures indeed.

I have always loved to watch the young of the orange back. They swim about slowly in the water, looking for all the world like miniature elephants, with a long, tubelike structure hanging down between their arms. Actually the "trunk" is formed by the two tentacles, which remain fused together until the animal reaches its juvenile stage.

Bony fish head, gnawed off by *Loligo's* beak, floats away as the squid prepares his meal. Turning the fish body lengthwise (below), he strips off the flesh, leaving skeleton and tail intact. Squids feed on anything they can catch, from plankton to large game fish and even other squids. Dissections of squid stomachs reveal undigested beaks, proof of cannibalistic feasts.

PHOTOGRAPHS BY ROBERT F. SISSON © H.A.B.



We don't know much about the life span of squids. *Loligo pealei* apparently lives for one to three years. Probably the Pacific squid survives only one spawning. The larger oceanic squids, such as the Humboldt squid and the giant *Architeuthis*, undoubtedly live for several years.

The giant squid has been known since earliest times by fishermen of northern Europe, and in distorted accounts of the Scandinavians it became the kraken—a gigantic sea monster that lay in the depths, holding the earth in its huge arms and rising occasionally to pull some hapless ship beneath the waves.

Unlikely? Yes, but in his *Kingdom of the Octopus*, author Frank W. Lane recounts a fairly well-documented case of a small pearl-

ing schooner being overturned by a wounded squid. He tells, too, of a giant squid during World War II pulling shipwrecked sailors from a life raft one by one.

To my knowledge, the largest squids attain a weight of about two tons and an overall length of some 60 feet, three-quarters of which may be arms and tentacles. But these rather sedentary members of the genus *Architeuthis* are seldom captured by man.

To supply squids as food for man and bait for fish, two major squid fisheries operate today in North America: at Monterey Bay, California, and in Newfoundland, the one there being the largest outside Japan.

So that I might study the Newfoundland squid fishery at firsthand, the National Geo-



ILLUSTRATION BY WALTER A. STREIB © NATIONAL GEOGRAPHIC SOCIETY

Blinded by a diver's light, a reef squid hovers with arms curled and mantle splotted with color. Thus camouflaged, he resembles drifting seaweed to the intruder in his underwater realm off the Florida Keys. *Sepioteuthis sepioidea* schools over and around the reefs, feeding on small fishes and shrimp.

graphic Society sent me, my wife (also a squid specialist), and photographer Sisson to St. John's, where Dr. Frederick A. Aldrich, head of the biology department at Memorial University of Newfoundland, turned his lab over to us with typical Newfoundland generosity.

Early next morning we sailed out into Conception Bay in Capt. Max Rowe's new boat. A drum bolted to the port gunwale held strong monofilament line carrying a series of cigar-shaped red, blue, green, yellow, and white plastic jiggers, their lower ends bristling with clusters of upturned, unbarbed hooks.

"That's the new Japanese squid-jigging machine," Fred explained. "In an hour, it can catch 2,000 pounds of squid while a hand jigger is catching only 600. It's revolutionizing the squid fishery in Newfoundland" (page 404).

As we drew near Holyrood, a bight at the head of Conception Bay, I could see a line of dories and launches moored offshore. Each boat held three or four fishermen. I watched, fascinated, as jigger after jigger came out of the water, each festooned with one to three foot-long squids attracted by the colorful plastic.

As soon as we anchored, we let the jigging line run out over the side. Then I started turning the crank, there was a slight tug, and as the jiggers came back the squids came up, arms wrapped around the jiggers and caught on clustered hooks. Each squid tried to jet away by squirting with its funnel. Within an hour Captain Max's newly painted white boat was stained black with ink from stem to stern, as was all our clothing.

Summer Visitors Vanish Mysteriously

So important is squid fishing in Newfoundland waters that a song entitled "Squid-jiggin' Ground" has become almost a national anthem. *Illex* comes into Newfoundland waters from the south in early summer, crossing over the Grand Banks and working northward to Labrador. By August most coves and bays in Newfoundland are crowded with squids. But no young have ever been seen, no eggs taken, and by mid-November the schools have left without a trace.

Almost all of the more than 11,000 tons of *Illex* landed in the Newfoundland fishery in 1964 was sold, in 40-pound frozen blocks, as bait for the Portuguese schooners fishing on the Grand Banks and off Greenland. Ask a Newfoundlander if he eats squids and the answer is almost invariably, "No! Who would eat fish bait?" But tell him first that you enjoy

eating squids, and the odds are that he will deluge you with recipes and tales of how many baked squids he ate the previous evening.

With squids so important to Newfoundland, Fred Aldrich is determined to make Memorial University at St. John's a leading center for squid research. Personally, though, his fondest interest lies in giant squids.

At one point, as we chugged home from the squidding ground, Fred asked me if I knew where we were. I nodded, and in my mind's eye I could see that day in 1873 when Daniel Squires, Theophilus Piccot, and Piccot's 12-year-old son Tom were dory fishing for herring in Conception Bay.

Bigger Giants Still Uncaught?

The fishermen, spotting a floating object, hit it with a boat hook and were horrified when a giant squid reared up from the water and seized the dory, almost swamping it. In terror, young Tom took up a bait hatchet and chopped off an arm and a tentacle. The dory righted itself, and the squid slid from view.

Returning to shore, the fishermen told a fearful, fantastic tale, but they had the monster's limbs to back it up. The tentacle, or only part of it, measured 19 feet long and 3½ inches in circumference.

Since Fred's arrival in Newfoundland, he has posted rewards for the capture of giant squids and questioned fishermen the length and breadth of the island.

Only a few weeks after I returned to Miami, I received a telephone call. It was Fred.

"I've got a big one," he crowed.

"Great," I answered. "I'm coming up."

Two days after his call, I again deplaned at St. John's. With the assistance of Fred's class, and under the eye of Bob Sisson's camera, we dissected the now-frozen squid. It was a female 21½ feet long (page 407).

A week later I had one of my own: the head and body of an 18-foot squid picked up dead off Miami by a charter-boat captain. It was the fourth giant squid from our waters to be turned over to me for study. The largest, caught in 1958, was 47 feet long.

Deep-sea research submarines now being designed and built with bow observation ports offer exciting prospects for more knowledge of the giant squid. When we can ride in one of these along the ocean floor, who knows what giants we may see sliding out of the dark? If I am riding in one, I only hope that the submarine is larger than the squid! THE END

THE AIRPORT HIGHWAY crossed a stretch of the classic Mexican West-wide, grassy plateau gilded by immaculate sun. The scene matched my memory until we saw the skyline. Here was the new, growing Guadalajara, second largest city of Mexico—six miles wide and 25 stories tall.

"That doesn't look like the pictures in our old album," said my son Kelly. Neither did he. Kelly was now 12; he had last lived in Guadalajara as a diapered baby, one of the half-million inhabitants of the proud old capital of Jalisco State. In the past dozen years, country roads had turned into avenues and neighboring towns had been swallowed as suburbs. Greater Guadalajara now claimed a population of 1,300,000.

Keeping pace, Kelly himself now stood five feet five: big enough to lug his own luggage, yet young enough to enjoy a trip with just his father. I was pleased. For years we had talked about his onetime home in the mild mile-high tropics, its famous flowers, its antique charm, and our friends lucky enough to live there still.

Mines and Mills Pour Out Wealth

"The one most Mexican city," residents call it—"what Andalusia is to Spain." And, true, the most romantic Mexican traditions spring from the soil of Jalisco.

Here, 300 miles west of Mexico City, the *charro* learns his horsemanship. Here, too, he chivalrously shares his big sombrero with dancers of the *jarabe* hat dance and the close-harmony troubadours known as *mariachis* (right). Jalisco farmers lead the nation in growing *frijol* beans and the corn for *tortillas* to wrap around them. And here Guadalajarans toast the good life—the glamor of their women and the swagger of their men—in Jalisco's own tequila, the national drink. Given a goblet and a good guitar, any loyal son is certain to burst into that musical exclamation "Guadalajara!"

But Guadalajara is more than a song. It's the booming metropolis of a dynamic state. From their three-and-a-half-million head of cattle, Jaliscans tan leather, then use it in their capital in Latin America's largest shoe factory. From Jalisco mountains, miners dig plenteous iron, lead, zinc, silver, and gold; they also produce 60 percent of Mexico's manganese—an important element in steel production.* Mills weave cloth and grind grain. Ovens toast cookies and melt glass. Jaliscans literally

*Bart McDowell described this nation's modern pace in "Mexico in Motion," *GEOGRAPHIC*, October, 1961.

cook with gas—brought by a new pipeline from Salamanca.

At the crowded airport (a new one is on order), foreign delegations jostle down the ramps; noting a prosperity that brings an annual population growth of 9.3 percent, they have come to copy Guadalajara's success secrets.

Down the new highway from Saltillo, a growing parade of tourists comes to the area's resorts, from Lake Chapala on the east to Puerto Vallarta on the Pacific shore (maps, page 416). They happily heap their shopping bags with beautiful bargain handicrafts. They

Guadalajara's *jarabe*, known to the world as the



THE MOST MEXICAN CITY

¡GUADALAJARA!

By BART McDOWELL, Senior Editorial Staff

Photographs by VOLKMAR WENTZEL, Foreign Editorial Staff

Mexican hat dance, captures the city's buoyant spirit with clattering heels and *mariachi* music.



Faith unites families at the Church of San Juan de Dios. Strong Christian and Indian traditions meet in the one million Guadalarans, or *tapatios*, who make this the second largest city in Mexico, after its capital. Balmy weather, exquisite churches and public buildings, fine restaurants, and romantic minstrels lure growing legions of tourists.



City's cruciform heart, shaped by spacious plazas, centers on the

sample some of Mexico's loveliest churches, greatest art collections, and most rewarding restaurants. Tourism has even brought its own ultimate symbol, the new Guadalajara Hilton Hotel. Our room there overlooked the wide valley of Guadalajara (pages 428-9).

"It is a very good land, truly populated and well kept, and I believe that if a town should be built in these parts, all would serve well. All that land is mild..." So wrote the far-from-mild conquistador Nuño Beltrán de Guzmán, when he first arrived in 1530.

The Spaniards came by way of a "very large lake" and a "town named Chapala." Kelly and I retraced their steps, starting, as recorded history did, at the region's foremost geographic feature, Lake Chapala (pages 418 and 430).

Search for a Friend From the Past

Fed by the Lerma River, Chapala is the largest lake in Mexico, and in its overflow is born the Pacific-bound Santiago River. Combined, the Lerma and Santiago form one of Mexico's most important river systems.



STREPPONE JUPPESSE AND KILLACHINE © N.S.A.

3½-century-old Cathedral of Guadalajara. Its 220-foot spires overlook the city hall's red-roofed quadrangle and (beyond right steeple) the palace of the Governor of Jalisco State.

Yet for Kelly and me the superlatives of history and geography were not as important as a personal quest on our 30-mile drive to Lake Chapala. We were looking for Maria.

"Don't lose Maria's picture," I warned Kelly. "It's our only hope of finding her."

I had lost her address and forgotten her last name. Yet Maria figured large in our family folklore as Kelly's first nursemaid. All our children knew of her. How she fed Kelly bananas from our own garden, bathed him in an earthen tub, and called him "Baby Mio."

They also knew of our leave-taking. When Maria learned we were going back to the United States, she sought comfort at her church.

"I have asked the Virgin," she told my wife Martha, "that when you and the señor return to your country, you will leave Baby Mio behind to live with me."

Maria remained confident of the miracle until the day we left. It was a tearful departure, for we took away not only Maria's Baby Mio but also, I fear, a little of her faith.

So lately, when Kelly's younger brothers



"Pearl of the West" thrives amid fertile farms and ranches, rich manganese mines, shoe and textile industries. A trade center fed by highways and railroads, expanding Guadalajara rapidly engulfs nearby towns.

River of swimming lights, rain-washed Avenida Juárez pulses at evening rush hour. Signs show French and U.S. influence.



were seining, and for a moment the setting seemed timeless: the sweep of steep, stylized mountains, the wide lake, the long-prowed fishing boats—all suspended in a kind of Biblical calm.

The spell broke with the put-put of an outboard on the horizon; 70 of the lake's 1,700 fishermen are now motorized. And just as well, for the tasty Chapala whitefish are eagerly bought by Mexican gourmets. We watched our shoreside fishermen draw in a small, flashing catch worth eight pesos (64 cents)—"not more," said one man.

Our human catch was even slimmer. We showed a fisherman Maria's photo, and he shook his head: "Sorry, I do not know her." It was a bad sign in a village of 3,400 people.

"But the picture isn't good," said Kelly, "and we haven't tried the church."

Five women were seated in the churchyard mending vestments when Kelly and I again produced the snapshot.

"Ay! Of course," said one woman. "It's Maria Vásquez. She lives here with her mother." In five minutes, a surprised Maria was shrieking with delight in her mother's patio. "But look! Baby Mio is taller than I!"

Her hair showed a trace more of gray, but Maria's life had changed little. She worked in the home of an American family in Ajijic. Her interests still centered around her relatives, church, and friends—and thus we had found her: not by name and street address, but through her enduring loyalties.

Perhaps, though, her worldly wisdom had grown: As we left, she no longer insisted that Kelly stay. This time she invited him back, "perhaps for the weekend."

Climate Aids a Passion for Sports

Maria typifies Jalisco's devout, family-conscious, and friendly people. Wholesome is the word for this part of western Mexico.

"When it comes to sports," said my friend José Angel Ochoa, "Guadalajarans are crazy." José should know; a former national tennis



and sister were annoyed with him, they urged us to "send Kelly back to Maria." Now Kelly wanted to call their bluff.

Vaguely I recalled that Maria's mother lived on the shore of Lake Chapala in a village called Ajijic. It seemed worth a try, though my own hope waned when I saw the lake. Along its brimming shoreline, my old landmarks had changed. A dozen years earlier, the water had been low and a few weekend villas had stood forlornly above dry piers. Now good rains had swelled Chapala to its proper 50-mile-long size. Here were clean beaches and cabañas for the 15,000 Guadalajarans who come by bus each summer Sunday.

Some 10,000 Americans—especially retired military families—live in the area, and many of them rent houses in the new subdivisions along the lake. We passed a sign announcing an American Legion post.

At Ajijic—in Nahuatl the name means "where water pours forth"—we drove down a cobbled street to the beach. Three fishermen



EL NUEVO PARIS

N
O
V
O

P
A
R
I
S

L

Paris

F
A
V
I
E
R

D

E

R



champion, he plays on the Country Club's clay courts twice each day.

"My wife and I go bicycling on weekends," a banker told me, "unless we ride horseback." He was typical—and 70 years old.

"It's the climate," a lady golfer explained. "My four-some hasn't missed a single day for more than a year."

Perched at a 5,000-foot altitude near the tropical 20th parallel, the city has no winter at all, just a nine-month dry season and three months with short, dramatic thundershowers in the afternoon and night.

In such a climate soccer, or *fútbol*, thrives. The city boasts more than 300 teams, three of them professional. One Sunday Kelly and I drove out to the new soccer stadium to join 50,000 impassioned spectators for a national championship game. The Club Guadalajara, seven times the all-Mexico winner, was defending its title against the Club America from Mexico City.

"The visiting team includes several Brazilians," one aficionado grumbled. "Ours is pure Mexican."

The visiting team met sarcastic shouts of "*Viva Brasil!*" The patriots prevailed, 2 to 0.

Tonalá Practices Arts Coronado Knew

Wherever we looked, we found Guadalajara a city of color and movement. The central plazas—framed by magnificent old buildings of yellow sandstone—look like formal foyers, but people crowd the walkways. Cars drive frighteningly fast; we even saw horse-drawn *calandrias*, or taxi-carriages, run stop signs. Along new boulevards, roses and dahlias bob brightly in the breeze, and fountains splash everywhere (pages 424-5). When I asked an official how many major fountains the city had, he named 32 without a pause.

Kelly and I combined our sightseeing with homework, stopping at bookstores as well as museums. And without meaning to—this being his vacation—Kelly learned both geography and history.

"This early governor—Francisco Vásquez de Coronado," Kelly asked as he read, "was he *our* Coronado?" Kelly had written a sixth-grade theme on the same Coronado's 16th-century explorations as far north as Kansas in search of the mythical golden cities of Cibola. Now we visited the old settlement of Coronado's time, going just beyond the southeastern outskirts of Guadalajara to the town of Tonalá.

The tile and adobe of Tonalá resemble a thousand other Mexican communities. Yet this town is special.

Inland fleet of Flying Dutchmen tacks in a race on Lake Chapala, a favorite playground 30 miles from the city. Clumps of floating water hyacinths plague the shallow 50-mile-long lake—largest in Mexico.

El suburbio: Ramblers and swimming pools dot a residential neighborhood of western Guadalajara typical of those that sprang from haciendas when the city mushroomed in the late 1940's.





PHOTOGRAPHS BY VOLMAR WENTZEL © W.S.S.



When the first Spaniards arrived, Tonalá was the seat of an Indian principality ruled by a widowed queen whose court, the chroniclers noted, had many fine artisans who "worked in silver and some gold and cloth."

In modern Tonalá we saw how the craft tradition still lives. The marketplace is piled high with terra-cotta ceramics (page 434). And in patio-factories, artisans still fashion fanciful clay animals and blow glass.

"Each village around Guadalajara has its own craft specialty," explained an American art dealer, Richard Pointer. "Jocotepec is famous for weaving white serapes. In Teocaltiche, men carve chess sets from bone. Tlaquepaque has a different pottery style from Tonalá's. These Indian cultures endure."

In proof, Mr. Pointer showed us a scarlet figurine—a bearded, horned animal carrying

pans and household pottery on its back.

"That's a *nahual*," said Pointer, "an ancient Indian bogeyman who steals things that people don't put away properly. Would you like to meet the artisan who made it?"

And so we met Cándido Medrano, a potter so small that Kelly looked down on his head.

Rebellion Brings Religious Feast

"When did you first hear of a *nahual*?" Mr. Pointer asked the little artisan.

"My parents told me of them long before I saw one," Cándido replied, his bright black eyes quite serious. And had he seen a *nahual* lately? "Oh, no, not lately, but then I do not leave my things lying about."

I thought of our hotel room and the tidiness of 12-year-old travelers. As a reminder, we took a *nahual* with us.



Indigenismo—"Indianism"—has historically been strong in Guadalajara. In 1541, after Governor Coronado took 1,000 men north on his wild gold chase, the Indians of this New Galicia rose in the Mixtón rebellion, the most dangerous uprising the Spaniards faced in three centuries of empire. The provisional village of Guadalajara—named for conquistador Guzmán's home town—barely missed annihilation; settlers fled an exposed riverbank for the higher, safer spot the city now occupies.

The rebellion came to a climax in a terrible battle. When the outcome seemed in doubt, a Franciscan friar raised a strange little standard: an image of the Virgin made of a corn cob. Miraculously, the Spaniards won. And the same Virgin, now known as Our Lady of Zapopan, is venerated throughout Mexico.

As the Patroness of Guadalajara, she has

Pagan finery of ostrich plumes adorns a solemn Indian outside the Basilica of Zapopan, as he strums an instrument made from an armadillo shell. His religious society performs in gratitude for cures considered miraculous. Members may represent Spaniards, always good; Moorish invaders of Spain, always bad; or Indians, always wise.

Parade of paper gods swirls past the governor's palace as tapatíos celebrate their October Festival. During the weeks-long extravaganza, each of Mexico's 29 states shows off its costumes, dances, and history. Pre-conquest Indians wore such masks of gods and animals to gain strength and cunning.

421

RICHARD WEAVER © NATIONAL GEOGRAPHIC SOCIETY







REPRODUCED BY HERTZ TOWERS © H.C.L.

Transfixed in reverence, villagers welcome the Virgin of Zapopan, Patroness of Guadalajara (above), to her home basilica on the outskirts of the city. Veneration of the Virgin dates from 1541, when Spaniards hard pressed by an Indian uprising raised the figure with its corn-cob body as a standard and won a victory. Three centuries later, invoking the image's aid in Mexico's successful revolt against Spain, tapatíos commissioned her a general in the Jalisco army. To this day, the Virgin displays the sash and gold baton of military rank. Fully costumed, she stands ten inches tall.

The Virgin reposes in a glass case at suburban Zapopan until June, when she begins a four-month circuit of city churches. Priests put on her quaint traveling hat, and reverent Jaliscans strew the streets with flowers. Then they place the image in a gleaming new car, take up ropes, and pull the vehicle from shrine to shrine along ways lined with worshipers.

her own basilica on the outskirts of the modern city; around it has grown a community of 60,000 people, Zapopan—once an outlying town, now a suburb.

Kelly and I saw the little Virgin when she was making her annual summer tour of all the churches in Guadalajara. She spends several days at each stop before her triumphant return home to the basilica on October 12 (preceding page). When we dropped by for a Sunday Mass, she was visiting the little Church of Los Dolores in a working-class parish.

In the streets around the church, paper streamers fluttered above makeshift kiosks. Vendors hawked food, fireworks, and lottery tickets. Inside, we paid our respects to the tiny robed image with doll-like face. A glass case protected her. Then we took seats beside an old man with a white beard and dark, strong features; he had come a long way, for his sandals and bare toes were dusty from the road. Behind us a baby, hammocked in his mother's shawl, babbled happily; the young father moved the child's chubby hand to make the sign of the



Water ballet of leaping plumes plays for a twilight audience at Alcalde Park. Where a refuse-clogged ravine once scarred the city, visitors now boat on a rambling lake, and children ride a miniature train called *el chucu chucu*.

Like holy candles, the Cathedral's spires gleam above the Plaza de los Laureles. After an earthquake toppled the original towers in 1818, tapatíos rebuilt them in ornate Neo-Gothic style. Before laying out the modern fountains and plantings, the city fathers built a huge parking garage underneath.



PHOTOGRAPH BY MELISSA BERTTEL © S.G.A.

cross. In front, a kneeling woman began to sing an improvised hymn, loud, throaty. Then the church bell engulfed her song in a large, dissonant call to worship.

When Mass was over, Kelly seemed puzzled.

“Do you suppose most of the people there were Indian?” he asked. I supposed they were overwhelmingly Indian. And I, too, thought it a little ironic that they should so venerate a symbol of Spanish victory.

Old Document Records a City’s Birth

Guadalajara bears no grudges. Its people have had centuries to mix and mellow. During the long colonial era, Guadalajara’s officials governed not only northern Mexico but what now makes up the southwestern United States—“the abandoned lands,” as they are archly called by José Cornejo Franco, distinguished historian and city archivist. The library dates from the year 1700, and holds even older 17th-century manuscripts written in the amber ink of *huisache* sap.

I tested the collection with a question about my birthplace, San Antonio, Texas.

“Oh, yes,” said Señor Cornejo Franco. “We have a bit on San Antonio—including the document of its founding in 1718: the birth certificate for the city of your birth.”

The colonial era left a rich legacy of architecture that we inspected, from the Cathedral of Guadalajara (page 415 and opposite)—remodeled after earthquake damage in 1818—to the richly worked smaller churches like San Francisco and Santa Mónica, as ornate and charming as a grandmother’s jewels.

In the hush of our tenth church, Kelly announced, “My feet hurt.” We adjourned to the marketplace to buy ourselves some *huaraches*.

These humble sandals—leather thongs stitched nowadays onto rubber-tire soles—are a typical local product. And the Liberty Market, across the street from the bull ring, offers the widest selection of shapes and sizes. Kelly tried on several squeaky pairs, bargained with a young *huarachero* his own age, paid

the equivalent of \$1.04, and pronounced his sandals "as good as going barefoot."

Then we explored the market itself, a multi-level concrete-and-tile wonder. Thirteen years ago, a young architectural student named Alejandro Zohn saw the need for a new marketplace and drew up a design as his term project. The city fathers knew a good blueprint when they saw one and built the Mercado Libertad for the hundreds of artisans and kiosk-keepers who now sell their wares there (opposite).

Among such stalls, early in the history of Guadalajara, Spaniards heard Indians refer to their smallest unit of money, the *tapatio*—three cacao beans. The Spaniards borrowed and hobbled the term to apply to themselves; today *tapatio*—noun or adjective—identifies anything or anyone Guadalaajaran.

Nothing is more *tapatio* than the Liberty Market. Here you can find whatever you want, be it saddle, needle, or hot tortilla. We bargained for a purse made of *caguama*, the

skin of a giant sea turtle, a carved chess set, some blue bubble-frosted glass, a guitar, a knife, firecrackers, some bulky paper flowers, and straw baskets to carry our loot.

Loaded down, we stumbled into the folk-remedy section and questioned the proprietor about his cures: rattlesnake skins (for skin diseases); starfish (heart trouble); the serrated blades of sawfish (asthma); armadillo shells (fevers); and organ cactus sliced into six-pointed stars (a wide-spectrum remedy for diabetes, cancer, and ulcers).

Minstrel Groups Audition in Plaza

Alongside the market, we hailed a waiting *calandria*. These brightly colored horse-drawn buggies are not really meant for visitors; they line up at the market as cheap private taxis for the poor. After shopping, we qualified. But our ride was short. Around one turn I saw the famous Plaza de los Mariachis, so we got down for a look and a listen.

What a stock exchange is to business, this plaza is to Mexican music. Here aspiring mariachi troubadours audition for restaurant owners and people who plan parties.

Some of the musicians were outfitted splendidly in short jackets and nickel-studded trousers that fitted like skin. Others had borrowed their finery from misshapen fifth cousins, but no matter. All sang with spirit, and most sang well.

Kelly counted 23 groups waiting and singing that afternoon. Ten pesos—80 cents—bought us a 12-man rendition of "Guadalajara!"

"The word '*mariachi*' comes from the French word '*mariage*,'" our friend Enrique Bremond told us later. "You recall Louis Napoleon's Mexican adventure."

I briefed Kelly on this bit of history—how during the U. S. Civil War the French Emperor Napoleon III set a puppet monarch,

Bargains by the acre jam Liberty Market, its skylighted roof covering an entire city block. At a food stand on the balcony, women flatten blobs of corn-meal dough to make *tortillas*. Shoppers on the main floor browse amid a bewildering array of foods, leather goods, locally made copperware, and such folk remedies as armadillo shells to cure fevers, sawfish blades for asthma, and rattlesnake skins for human skin ailments.

Stringing edible necklaces of small apple-like *tejocotes*, a street vendor waits for customers in suburban Tonalá.





Maximilian, on a Mexican throne. After Appomattox, I told him, the U. S. reaffirmed the Monroe Doctrine, and—as a Mexican fourth-grade textbook put it—“with Mexico’s fierce resistance and considering to some degree the power and attitude of the United States, Napoleon III decided to withdraw.” The legitimate Mexican government under Benito Juárez returned.

“Some of the French troops preferred to stay near Guadalajara,” said Enrique, “especially in the little town of Cocula. They fell in love with Mexican girls, for who can resist their beauty? And for the wedding feasts they hired local musicians—thus marriages, or mariachis.”

Don Enrique, schooled in France by his French-Mexican father, was himself unable to resist the beauty of a Mexican girl—now his glamorous wife Martha.

Touch of France Enlivens the City

Other French-Mexicans add to Guadalajara’s Gallic air. Two leading department stores are the Nuevo Paris and the Fabricas de Francia. A posh club, Le Cercle Français, claims 300 members. And it was in a club named for Montparnasse that I attended a Fourth of July party sponsored by the American Society. Toasting George Washington in tequila, the crowd of patriotic expatriates was highly heterogeneous. I listened to barber-shop quartets and watched jarabe dancers.

“The international touch has always been good for Guadalajara,” said my friend José Ochoa. “Look at the beauty of our women!”

Kelly and I confirmed José’s claim at the Plaza de Armas. There, around a 19th-century bandstand, Guadalajarans turn out for traditional evening serenades and *paseos*.

The band plays, flower vendors mobilize, and people promenade—boys one way, girls the other. When the right boy meets the right girl, they flirt, and after a few romantic laps, the boy may give the girl a flower and a few flowery words.

The plaza was packed that summer night. “Just wait,” said a bystander. “The band will play a medley of romantic American songs—to honor the many students of your country who have come for summer courses.”

We waited, and sure enough, along came “Columbia, the Gem of the Ocean,” “Dixie,” and finally “Nearer, My God, to Thee.”

In the confusion of music, twilight, and flowers, we met some young American scholars. One, green-eyed Jane Myers, 19, of Beloit College in Wisconsin, had enrolled with eight



Mile-high plateau provides ideal weather and growing room for the sprawling city. Skyscrapers at center—an office building



RESEARCH BY VILMAR BENTZ © NATIONAL GEOGRAPHIC SOCIETY

and the Guadalajara Hilton Hotel—tower near Agua Azul Park, whose trees conceal a zoo. Straight as an arrow, Independence Boulevard streaks from Juárez Plaza seven miles to the rim of the Barranca, an immense canyon carved by the Santiago River beneath distant foothills.



"Landscape for souls in love," sing the mariachis of Chapala. In the shallows, wading

schoolmates for a summer course at the University of Guadalajara.

"We've dated almost every night," said Jane. "And since we live with Mexican families, we're running into the chaperone system."

By old Spanish custom, the chaperone, or *dueña*, was a maiden aunt who kept a sentry's watch over girl and suitor.

"The chaperone is expensive," complained 20-year-old Luis Navarrate. "We must buy her dinner on a date."

"But a good idea," insists Guadalajara's 36-year-old mayor, Eduardo Avina Batiz. "My wife and I met at a family party. We were always chaperoned."

Backdrop to the Plaza de Armas is the Government Palace. History itself has promenaded beneath its sandstone arches. In 1810 an aging parish priest exhorted his fellow Mexicans to rise against Spain, and Father Hidalgo's cry launched national independence. He led his patriots to Guadalajara,

used the palace as his capitol, and here freed Mexico's slaves.

In 1858 the Lincolnesque Benito Juárez brought his exiled government here; on a second-floor arcade, he narrowly missed being killed by mutinous soldiers. In 1915, during the Revolution, the flamboyant Pancho Villa strutted through the Guadalajara palace. And on the inside of walls slotted for rifles and pocked by bullets, Guadalajara's own José Clemente Orozco fired violent volleys of paint—murals that now prove him a giant among Mexico's Revolutionary painters.

We visited Orozco's studio-home in the suburbs to see a cross section of his work, then traced his trail of powerful frescoes to the university and to the Hospicio Cabañas.

For a decade after the master's death in 1949, Guadalajara seemed an artistic vacuum. But now a new generation is emerging. Open-air art classes in Agua Azul Park draw 200 painters on a Sunday afternoon. Art museums



fishermen gather their net at day's end.

are full. New buildings are covered inside and out with frescoes and mosaics.

"Look at this," said Rodolfo Lozano, Sr., as he showed us sketches for a new fresco—people at play, feasting, enjoying flowers. "This is to be the ceiling for an operating room in a clinic. Imagine! The last thing a patient sees before his anesthetic. As he falls asleep, we give him an incentive to live!"

Architect Sparks Urban Renewal

"Yes, art is closely tied to life here," said the former city mayor and present governor of Jalisco, Francisco Medina Ascensio (page 436). "Beauty is valued in the home." We were talking in the bright patio of his official residence, where beauty was obviously valued.

"Our old customs help us keep Guadalajara a provincial city," he continued. "Stores close from two to four, so men go home to lunch with their families. Then there are spiritual values. Our neighborhoods are grouped around the

String of catfish delights a youngster of lakeside Ajijic. Chapala also yields a tiny whitefish widely acclaimed by gourmets.

ESPINOZA (LEFT) AND RODRIGUEZ (R.S.S.)



local church and the market—very Mexican.

"We do not want a deformed city. Great apartment skyscrapers would be so ugly! A man must hang a towel out the window to see which place is his! Instead, our low-income housing projects have only individual homes—never more than 100 in one place. And each house costs 10,000 pesos—less than \$1,000.

"We have some poverty here in Guadalajara, but we do not have real misery. And it is very important that families not be given these houses gratis. To conserve their own dignity, families must buy.

"For the same reason, we make a token charge of 20 centavos—less than 2 cents—at our public parks and at our new community centers. You must see these things."

That afternoon, the governor and I made a long list of projects and people to see—a guide to the new Guadalajara and an anthology of success stories. A key figure was

architect Ignacio Díaz-Morales, founder of the University's School of Architecture—and a National Geographic Society member “since I saved up for my first dues in 1927.”

In 1944 Don Ignacio was engaged to restore the Cathedral. To replace broken stones, he sent his workmen out to rediscover the original 16th-century quarries of the golden sandstone called *cantera*. He examined old drawings and plans. And then one day he climbed the Cathedral spires: “I looked out over the city and saw—such possibilities!”

Others might have seen only a jumble of old buildings and narrow streets. But framing this clutter were some truly distinguished structures: the great Cathedral itself, an old convent, a theater, a towered little church,

the Government Palace. They defined an elegant rectangle (pages 414-15).

“I thought of the central space—a place for real serenity. And I thought of the money it would take to clear it,” Don Ignacio recalls. “We had no money. But because Guadalajara is my sweetheart, I drew plans anyway. Then in 1947 a new and strong man became governor—José González Gallo. He asked to see my plans and immediately told me, ‘We’ll do it!’ And he did.”

The wreckers’ wounds were still fresh a dozen years ago; the Cathedral was a lonely island in a vacant, sun-baked lake of new pavement. Today Don Ignacio’s serene space is lush with roses, dahlias, jacaranda trees, and fountains; few cities in the world can



boast a more charmingly planned civic center.

Out the Avenida 16 de Septiembre stands the Industrial Bank of Jalisco, nicknamed "the Basilica of Money." The founder of this, one of Mexico's largest provincial banks, is a calm gentleman, Félix Díaz Garza, with the face of an El Greco saint.

Bumper Crops of Corn and Character

Don Félix has a simple explanation for the bank's success. "We recognize a man's character as a capital asset," he said. "We know the people we lend money to."

Don Félix knows the land, too. "Note the balance of our Jalisco crops," he said, producing a list of figures. "Corn is our great crop, worth some 90 million U. S. dollars a year. But

that is less than half our agricultural total. Frijoles bring us more than \$1 million dollars, then come sugar cane, peanuts, and wheat. See here? With new roads and markets, our tropical fruits are increasing—we're shipping far more bananas and oranges. Our different altitudes give us so many climates.

"And, of course, in another way we are geographically privileged. Guadalajara is the westernmost metropolis of Mexico, and thus a natural distribution point."

I noted that Mexico had other western cities, some with seaports. Why should Guadalajara outstrip them?

"Our secret?" Don Félix smiled. "It is so simple: We are united." Then he talked about the Consejo de Colaboración, or Council for



PHOTOGRAPHS BY VOLKER WENTZEL © N.A.S.

Using a flame like a knife, a sculptor in glass shapes a miniature horseman. Melted-down bottles yield most raw material for figurines at the Avalos Glassworks.

Once they painted bathtubs for Spanish nobility, but today the artisans of Tlaquepaque decorate giant jars. From this suburban town and neighboring Tonalá, colorful pottery flows to markets throughout the world. A local museum preserves treasures of ceramic art predating the Spanish conquest.

Pots full of pots await buyers in Tonalá; a mother pursues a potential threat to the crockery. Tapatíos insist that *pozole*, their everyday hominy fare, cooks properly only in a bowl made of fine Tonalá clay.

Municipal Cooperation. "It represents all of us: labor, capital, the state. It is unique."

The council chairman is also president of the Chamber of Commerce, Jorge Garibay, a big fellow with the salesmanship of a car dealer—which he is when his unpaid civic chores permit.

"We get things done," said Señor Garibay. "Like the neighborhood of Talpita, for example. The people had no water service. The government had no money for pipe. Well, the consejo got neighbors together, and they decided to do it themselves. We found contractors, got estimates and credit, and divided the cost fairly among home owners. We collected the bills. To pay our expenses, the consejo charged 5 percent for service. Now Talpita has water—without government funds."

I mentioned the neighborhood community centers. "Marvelous project!" said Señor Garibay. "I remember when the district of La Federacha had 19 noisy bars, with many stabbings. Then we got a community center built—very simple, tables for games and cold refreshments, a television set, a little library, and washtubs. Today La Federacha has only one bar—and no stabbings!"

Charro—Knight-errant of Mexico

Through my short interviews and long (Kelly recalls the longest as four and a half hours), my son listened to Spanish and learned a bit. Aside from a few pleasantries, his first Spanish words were *comida* (meal), *más, por favor* (more, please), and *charro*. "That word means more than just cowboy, doesn't it?" he asked.

And right he was. A *vaquero* is a working cowboy. A *charro*, outfitted dashingly and performing Jalisco-style in a rodeo, is a good bit more (pages 438-9). Often he is rich.

"I do not wear those suits lightly," said swarthy six-foot-two Manuel Manzo Pineda. He was showing us the nine costumes and saddles he keeps in his office—a collection easily worth \$10,000. "When I wear the suit of a charro, I feel a spiritual responsibility."

Put simply, the charro is part rodeo performer and part knight-errant. He travels, seeks adventure, proves his skill on horseback, and displays true generosity of spirit.



He also has fun. And we shared it one afternoon at the Ignacio Zermeño Padilla Ring, a private stadium in residential Guadalajara.

"The ring is named for Don Ignacio Zermeño," said our friend Rubén Ríos Ahumada. "Let me present him."

Don Ignacio, at 70, was a kind of cowboy King Arthur. From boots to umbrella-size sombrero, he was clad in suede perfectly matching his suntan. He swept off his hat, bowed, and said, "Your servant." Then he excused himself to lead the parade that starts each performance. Behind him on fine horses



STYLING: JIMMY © NATIONAL GEOGRAPHIC SOCIETY

rode two of his sons and one two-year-old grandson, firmly strapped to his own horse.

"This is only a small sample," said a man next to us in the tiered amphitheater. He was Manuel González Ortega, treasurer of the National Association of Charros and one of the three men who qualify as official judges of the contests for roping and horsemanship. "This afternoon we have only 15 contestants. But 20,000 charros belong to our association—and 10,000 of them live in Jalisco."

Riding sidesaddle in a red-ruffled skirt, a pretty charra named Marta Beatriz Revilla

made her bay gelding dance like a chorine. Then 14-year-old Jaime Cuevas performed some exhibition rope tricks.

"These arts came to us from Salamanca in Spain," said judge González Ortega. "But through the centuries, they have changed."

The first *suerte*—literally "luck"—was mustang roping. The judge explained how he scored each movement: from the number of overhead twirls of the lariat to the foot or feet it catches. One at a time, the contestants rode out with a thunder of hoofs through a veil of dust. No man missed.

Mighty swat dooms a candy-filled *piñata* at the Hospicio Cabañas, an orphanage founded in the 18th century. Eager playmates wait to converge on the treasures that will spill from the paper figure. Also made of straw or clay, piñatas may hold fruit, candy, or toys in this traditional children's game.

Walls of the Hospicio bear some of the finest murals of José Clemente Orozco, a Guadalupeño and one of Mexico's most illustrious 20th-century painters.

Visiting VIP: Jalisco's Governor Francisco Medina Ascencio makes a surprise call at a school serving a public-housing project in Guadalajara.



"Now note the tailing of bulls," said our friend. "It's like your bulldogging, only we use the tail instead of the head." Torn between admiration for the charros' skill and sympathy for the bulls, we watched as men wrenched down animals five times their weight.

"The public loved our exhibits in Spain last year," said the judge. "We chartered three planes for the tour—and sent 20 horses ahead by boat. The exhibitions earned more than 500,000 Spanish pesetas for charity."

"Was that net, after expenses?" I asked.

The judge looked embarrassed. "No charro can accept payment. No, no. Each man paid all his own costs." Who could suggest an expense account for a prosperous Lancelot?

If the age of chivalry lives on here, so does

a touch of the Renaissance. "These are strange people," said one American resident. "Part universal man, part George Babbitt."

"Our city needs every skill a person can develop," said a Mexican teacher. "We must be versatile." They are.

Bankers Back Artists; Dentists Are Dancers

With a Medici touch, an industrial bank commissions historians to write books, then publishes them. A large savings and loan firm sponsors singers; after their studies in Italy, the firm distributes their recordings.

One evening Kelly and I went backstage at the new Experimental Theater to watch a local company do folk dances. The pretty director, María Guadalupe Sandoval Ramírez,



STACHPURE (OPPOSITE) AND RODRIGONE © R. G. E.

explained the rhythmic stamping of various Jalisco dances—the Jarabe Tapatio, the Jota, the harvest-season Culebra. Then she told us, “I am a dental surgeon and a schoolteacher. All of us dance for the love of it. We have three engineers, many students, all amateurs.”

If a dentist who also dances and teaches seems versatile, so must the city’s amateur astronomers. “The street traffic causes us trouble,” says architect-engineer Frederick Mardus. “The soil here is not extremely rocky, but it transmits vibrations more than one might expect. Bad for our observatories.”

Vibrations do not deter Dr. Acero de la Fuente, a physician, from studying solar X-rays, nor textile manufacturer Carlos Braen from his research on micrometeorites.

We met the most Leonardo-like of Guadalarans at a meeting of the local Society of Geography and Statistics. The featured speaker, Aurelio Robles Castillo, was delivering a paper titled “Geographically Mutilated Jalisco.” Afterward we learned more about this amazing man. He owns farmland and opal mines. He paints in oils. He writes poetry and novels and publishes a weekly newspaper. He has produced motion pictures, and he composes popular music.

Often we examined the mutilated geography of Jalisco, whose name stems from a volcanic stone called *jal*. One jaunt took us to the Barranca, the canyon of the Santiago River. Some promoters compare this chasm to the Grand Canyon of the Colorado, but the



2,000-foot-deep gorge is special in its own way. These red cliffs, carved by sudden and frequent floods, reveal the geologic history of western Mexico (pages 440-41).

Over the ledge of the new highway, we could look down upon the back of a high-flying *copilote*, the ubiquitous vulture. Beyond and beneath him stood improbably blue *tabachin* trees, their blooms like nosegays. Thermal streams burst from this troubled earth, and we watched the waters of one steaming spring spill from a ledge to fill a chasm with rainbows.

The road rolled on in centrifugal descent, and our car grew hot. In theory, we should be adding only 3.5° Fahrenheit for every 1,000 feet of altitude we lost. But because we had left the cool breezes on the canyon rim, the rocky bluffs worked like oven walls. We skinned off jackets. Soon we stood, sweating, beside the murk and spume of the Santiago River.

Long before written history, this was the

border between civilized Indians and the Chichimecas, or wild men. Now the Santiago inscribes another sort of human frontier. An ambitious 20-year project, the Plan Lerma, proposes to harness this river system with ten new hydroelectric dams and irrigation canal-and-tunnel systems—some of them 125 miles long—carved through rock.

Rain for Jalisco Crops Vital to Mexico

Elemental geography is never far from the *tapatio*. Mexico's 41 million people would be hard pressed for their staff of life, corn, without the State of Jalisco. Here rainfall varies between 8 and 55 inches a year; a local drought can mean a national disaster.

One afternoon we stopped at the Guadalajara Cathedral to call upon His Eminence José Cardinal Garibi Rivera, the first Mexican cardinal in history. We talked for a time about his archdiocese, its two million communicants, 1,141 churches, and 742 priests—the



STOCKHOLM (LEFT) AND BOULDER (RIGHT) BY VILANOR WENTZEL © N.A.A.

Toro by the tail! In a variation of north-of-the-border bulldogging, a Mexican horseman grabs a bull's tail and attempts to swing the animal off its feet. Spectators crowd the arena for the rodeo, one of Mexico's most popular sports.

Heir to gallant tradition, a teenage *charro* holds his finely bred mount—as much a part of him as sombrero and suede suit. His father and 11 brothers and sisters; all *charros* and *charras*, mastered feats of riding and roping to earn membership in Mexico's elite group of horsemen. Starring in rodeos and fiestas, they live by a code of chivalry and proudly disdain payment. The National Association of *Charros* has 20,000 members, half of them in Jalisco.



most of any diocese in Latin America. Then, inevitably, the talk turned to terrain and rain, for the cardinal has trudged all over his native Jalisco for most of his 77 years.

440 "I remember once a few years ago when we visited San Gabriel," said His Eminence, eyes laughing and owlish spectacles slipping down his nose. "A great thundershower and a flash flood blocked our path. We took refuge in a country school and slept there." He laughed,

and his benign, round face somehow resembled that of Pope John XXIII. "Another time I had to wade a stream to reach a village church. Everyone was disturbed because I said Mass while still wet. They brought me dry clothes, but I had already started the Gloria. Even now, with better roads, a pastor sometimes gets soaked to the skin."

Roads, rain, and untamed geography will play their part in Jalisco for a long time to



come. South of the Sierra Madre Occidental stand ranges 9,000 feet high, barriers between Guadalajara and the Pacific. Yet, says Governor Medina Ascencio, "the future of Jalisco lies on the coast." After 34 years of road construction, highway engineers have finally reached south to the Pacific at Melaque. Soon the great beaches of Puerto Vallarta and Tena-catita will be within reach of the automobile.

As a farewell toast to Guadalajara, Kelly

PHOTOGRAPH BY WILHELM WERTZEL © N.S.C.



and I toured Jalisco's largest and most typical industry: tequila. Some 75,000 people work in the agave plantations, the distilleries, and the bottling plants that give Mexico its national drink. We inspected this work with attractive Señora Margarita Gutiérrez de Fendt. I recalled that the tequila industry's salty rebuttal to the daiquiri is called the Margarita. "Any kin?" I asked.

Doña Margarita laughed. "The name's the same, but we don't claim the invention."

Then we heard from Doña Margarita a curiously Shakespearean love story.

Happy Ending for Romeo and Juliet

Once upon a time in Guadalajara there lived two competing tequila-making families, Sauza and Cuervo. They had always quarreled, and for a generation they had exchanged both insults and pistol shots. Sauza children never met Cuervo children in Guadalajara. But then young Javier Sauza went to a small university in Chicago. "And who should he meet there," said Margarita, "but my sister María Elena Gutiérrez, a Cuervo relative. Like Romeo and Juliet, they fell in love. They married secretly. When Javier's father found out, he cut off his pampered son completely.

"Javier had to learn how to work—to support his wife, he once worked as a guide in Mexico City. Well, the father finally relented, and the feud ended just before the old gentleman's death. Javier and María Elena have now brought cooperation to the tequila industry. The old competitors work on the friendliest terms."

Don Javier, gray, bright, and distinguished, now feels the experience was good. "I knew nothing of tequila—had nothing to unlearn."

And his Doña María Elena, the mother of grown children, is still a pretty Juliet. "A true story," she smiles, "with a happy ending."

We felt the same way about our two-month stay. From the length of Kelly's trousers, I could see that he had grown at least an inch. And in the same time, Guadalajara had added 10,000 people to its population. The story of this most Mexican city was true and happy—but the ending was not yet in sight.

Through childhood's world, young tapatíos wander in search of wildflowers. The Santiago River, flowing from Lake Chapala, cleft this mighty canyon in Guadalajara's plain. Once a barrier between civilized and wild Indians, the Barranca will eventually hold ten hydroelectric dams that will work an industrial revolution.



“Snowflake”

THE WORLD'S FIRST WHITE GORILLA

By ARTHUR J. RIOPELLE, Ph.D.

Photographs by PAUL A. ZAHL, Ph.D.

National Geographic Senior Staff (Natural Sciences)

IT IS EARLY MORNING, deep in the jungle of Río Muni, Spanish Equatorial Guinea. Fog drifts through a tiny clearing, obscuring thatched roofs and plots of bananas and coffee. Suddenly two shotgun blasts pierce the stillness. Villagers rush from their huts to Benito Mañé's banana grove.

A gorilla has ripped a banana stem apart, opening it with powerful hands to get at the savory pith. Benito, a farmer of the Fang tribe, has killed the marauder, for his livelihood is at stake.

Now Benito points in astonishment at a small creature clinging to the fallen gorilla, head buried in the long black hair.

“*Nfumu! Ngi!*” he exclaims.

White! Gorilla!

Word of this remarkable event—the discovery last October 1 of the only white gorilla known to science—reached me promptly, though I was nearly 7,000 miles away.

“The animal is magnificent, healthy, vivacious, but still very aggressive,” wrote Spanish naturalist

Appealing as an impish boy, the animal kingdom's newest celebrity munches a banana while studying a curious world with friendly blue eyes. A farmer found this first known albino gorilla clinging to the body of its mother—a black ape slain as she raided a banana patch in Río Muni, an African province of Spain. The sight astounded the captor; not even tribal myths recalled a white gorilla. Nicknamed *Copito de Nieve*—Little Snowflake—the pug-nosed primate adjusts to a strange new life in Barcelona.

ILLUSTRATION © A.G.S.



© A.G.S.



Gorilla country: Equatorial rain forest of northern Rio Muni towers above the author and naturalist Jorge Sabater Pi as they photograph the great apes' habitat. Señor Sabater (left), who obtained Snowflake for the Barcelona zoo, participates in a National Geographic Society-sponsored field study of lowland gorillas conducted by the Delta Regional Primate Research Center of Tulane University. Dr. Riopelle heads the center.



BOGACHROME BY JORGE SABATER PI (RIGHT), ENTREPHUME (ARBORE) AND BOGACHROME BY PAUL B. ZAPF © N.G.S.



Ink-black orphan shows the usual pigmentation of baby gorillas. This eight-month-old female suffers from undernourishment. Angry sores acquired in the wild scar her wrinkled little face.

Romping in new elephant grass, Snowflake lopes over the grounds of a collection center in Bata, Rio Muni, where Señor Sabater conditions animals to captivity. In good health when found, the youngster soon lost his fear of man and cheerfully accepted his new adventure. Tooth development indicated an age of two years for the 19 $\frac{1}{4}$ -pound ape. Though capable of standing erect, gorillas prefer to move on all fours.

445



Jorge Sabater Pi from Bata, seaport capital of Rio Muni. "I work to tame him."

As Director of Tulane University's Delta Regional Primate Research Center, near Covington, Louisiana, I was excited by this startling news. Under National Geographic Society sponsorship, we had just launched an extensive study of lowland gorillas, which abound in the Spanish province of Rio Muni. I immediately notified the Society.

Jungle Ape Adopts Civilized Ways

Señor Sabater heads the Bata animal acclimatization station of the Barcelona zoo, with which we are collaborating. After taming the unique gorilla, he shipped him to Spain.

To learn the details and make a photographic record, I flew to Barcelona as soon as possible with Dr. Paul A. Zahl of the National Geographic's staff. We found the white gorilla living in the home of the zoo's veterinarian, Dr. Román Luera Carbó.

Officially, he will be called Nfumu, "white" in the tribal language of his captor. But I suspect the world may continue to use the appealing nickname the zoo director, Dr. Antonio Jonch Cuspínera, bestowed on him at first sight: *Copito de Nieve*, Spanish for Little Snowflake.

Already, I saw, Snowflake had captivated his captors, as he soon did Dr. Zahl and me. The affectionate little ape demanded attention, grunted contentedly while being cuddled,

laughed delightedly when tickled, and showed no sign of homesickness.

We judge that Snowflake, at the time of his capture, was about two years old. He is a typical young gorilla in every respect but one: He is an albino, lacking normal pigmentation in the eyes, skin, and hair. His hair is white, his skin pink, and his eyes blue.

From Spain we flew on to Bata, where Señor Sabater told us the full story. Benito Mañé had kept the foundling in his own home for four days, lining its cage with leaves, ferns, and sticks, much as a gorilla builds a nest, and feeding him wild fruits, stems, and buds. Then Benito took Snowflake to Bata, where Señor Sabater purchased him.

"He was coated with red road dust," the naturalist said. "I promised him a bath *mañana*."

At the animal station, the young gorilla was weighed (19¼ pounds—about 10 pounds less than an average human of the same age), bedded down in his new cage, and given a pan of milk. If he drank this most nearly perfect food, rich in the protein that wild animals usually obtain only with difficulty, his chances of adapting to captivity would be greatly increased. Snowflake drank it. His acclimatization had begun successfully. But he screamed and tried to bite next day when Señor Sabater and his wife bathed him.

Taming proceeded slowly at first. By the sixteenth day, however, he allowed himself to be touched on the head, ears, arms, legs,



Screaming in protest, the motherless ape gets his first bath. Two assistants hold Snowflake while Señor Sabater's wife scrubs.

With eager fingers, Snowflake strips sweet fibers from a stalk of sugar cane. His expressive face, here resembling that of a wise old man, delights a young neighbor of the Sabaters. Gorillas also eat fruit, stems, and buds of *Aframomum* (cover photograph), a member of the ginger family; *Misanga*, an umbrella-shaped tree; and banana plants. Snowflake has learned to relish cookies, milk, and baked ham as well.





EDUCATION BY JORGE SABATER AT LAMBEY AND PAUL A. 1966 © N.S.S.



and back. Soon permitted to leave his cage, he followed anyone who showed him a favorite food—bananas, sugar cane, cookies, or milk.

"We worked with him for at least an hour in the morning, and another hour in the afternoon," said the naturalist.

At the end of a month, Snowflake was walking hand in hand with people he knew well. He played alone, clapped his hands, and turned somersaults. And he followed Señor Sabater and his wife everywhere. Now the little Spanish subject was ready for the flight to Spain and eventual exhibition at the Barcelona zoo.

I have wondered—as you may have—why we have never before seen a white gorilla. Frankly, I doubt that others exist. Snowflake's unfortunate mother was a black lowland gorilla. The odds are incalculably large that his unknown father was also black.

Very little is known about lowland gorillas. More than 5,000 of these secretive animals roam the dense rain forests of Rio Muni, though it measures only 80 by 125 miles. It's a perfect laboratory for our field study.

Tulane's Primate Center is one of seven in the United States built and largely supported by grants from the National Institutes of Health. We investigate human problems for which monkeys and apes might prove especially helpful as experimental subjects.

To do our job, we need to know more about the nonhuman primates. I am hopeful that our scientific studies of Rio Muni's gorillas over the next few years will produce new knowledge that will aid man in his fight against disease and also help him to protect these magnificent animals themselves.

Companionship and affection reassure Snowflake. He delights in boyish roughhousing with eight-year-old Francesc Sabater. In Barcelona, Snowflake greets his new "father"—Dr. Román Luera Carbó—with a hug. The zoo veterinarian and his wife kept Snowflake in their home to prevent loneliness from sapping his good spirits; here they watch their charge enjoy a cookie. If the albino reaches adulthood, he may attain a weight of more than 500 pounds. Unless he were mated with another gorilla carrying albino genes, scientists see no chance that he could pass his rare lack of pigmentation to an offspring.

SIX-MONTH INDEX AVAILABLE

As one of the benefits of membership in the National Geographic Society, an index for each six-month volume will be sent, upon request, to members who bind their *GEOGRAPHICS* as works of reference. The index to Volume 130 (July-December, 1966) is now ready.

CAPRICE

The Grand Chevrolet



The 1967 Caprice Custom Coupe



Caprice is a very special Chevrolet. It's elegant. It looks like an expensive car, rides like one and is loaded with extras. Extra special features like a fold-down center-armrest and extra long armrests on the doors. There's a warm, rich look of walnut paneling and an

acoustical ceiling to keep noise out and nice sounds in. The wall-to-wall carpet climbs right up the doors. Caprice has its own special interior, its own special outside trim—its own special look. See your Chevrolet dealer and see how little this special treatment costs.



MADE BY EXCELLENCE

It looks and behaves like costly cars.
But it's different.
You could fly to Europe and back
on the difference.

Get that sure feeling



Doing business with a broker —

— is easy!

If you walk into any Merrill Lynch office, for example, you'll probably be introduced to an Account Executive — a man we hire and train to know all that he possibly can about helping investors.

If you've never bought a share of stock — and millions of people who could have done so haven't — don't be surprised if he doesn't rush to open your account.

Chances are he'll want some idea of your over-all financial situation — so that he can try to determine the risks you can afford, the rewards you hope for.

He may give you copies of our two basic primers on investing, "What Everybody Ought to Know About This Stock and Bond Business" and "How to Invest" — and suggest that you read them first.

On the other hand, you may have a certain stock in mind already and — after discussing it with your Account Executive — feel that it's ideal for your situation.

In that event, you may want to open an account and buy some.

And that's easy, too.

First, you establish your credit, usually through a bank. After that, if you're an American citizen over 21, all the Account Executive has to know is your name, occupation, and Social Security number.

From then on you're a customer — entitled to all the services we provide for anybody who does business with us.

Oh, one other thing might happen. If several stocks are involved, the Account Executive may want our Research Division to prepare a tailor-made portfolio that seems to fit your personal needs.

There isn't any charge for this, and you're not obligated in any way. You can talk the Research suggestions over with your Account Executive — follow them or not, at your own discretion.

And that's about all there is to it.

Once your account is opened, you'll probably find, like most of our customers, that any future transactions are as simple as a phone call.

Or, as we said, doing business with a broker is easy.



MEMBERS N. Y. STOCK EXCHANGE AND OTHER
PRINCIPAL STOCK AND COMMODITY EXCHANGES

**MERRILL LYNCH,
PIERCE,
FENNER & SMITH INC**

70 PINE STREET, NEW YORK, N. Y. 10005

TAKE STAIRS SITTING DOWN WITH

A *Stair-Mobile*



- easy, sensible way to get upstairs
- operates on house current
- foldaway feature allows free passage on stairs
- exacting safety features
- very moderate cost

Write for brochure

Southeastern

ELEVATOR CO., INC.

P.O. Box 8677, Dept. G • Atlanta, Georgia 30313

BARGAIN FROM LONDON

Battle of Britain Set

Plus 103 DIFF. BRITISH COLONIALS



ALL
25¢

Historic 25th Anniversary set of 6 provocative designs commemorate 1940 Battle of Britain! Action scenes of Spitfires and Nazi raiders! You also get giant parcel of 103 diff. British Colonials, including Rhodesia Golden Jubilee, Tanga Coat of Arms, Tristan da Cunha Map, many others. All yours for just 25¢ — bargain export price to introduce overseas approvals.



FREE

If you act now!
25-year-old Queen
Victoria penny red
imperfect. Third
Stamp ever issued!

IMPORT DIRECT. SAVE 20-60%. Buy direct — where dealers buy. Exciting selection, low prices the easy 14 day approval way.

SEND 25¢ IN UNUSED U.S. STAMPS (NO COINS). ASK FOR LOT VZ14
BROADWAY APPROVALS, LTD., 50 Denmark Hill, London S.E. 5, England.

MINNESOTA

LAND OF 10,000 THINGS
TO SEE AND DO!



Plan a marvelous
vacation with
this colorful book.
FREE from
Minnesota!

For Free Minnesota Vacation
Planning Kit send coupon to:
Vacation Information Center
State Capitol, Dept. 17-M
St. Paul, Minnesota 55101



Name _____
Address _____
City _____ State _____



THE CHRYSLER CREW COMES THROUGH FOR YOU!



Beautiful new Hydro-Vee boats offer more fun per foot. Chrysler 15' Charger 183 has a total hull capacity of 183 cubic feet. (Calculated according to B.T.A. formula.)

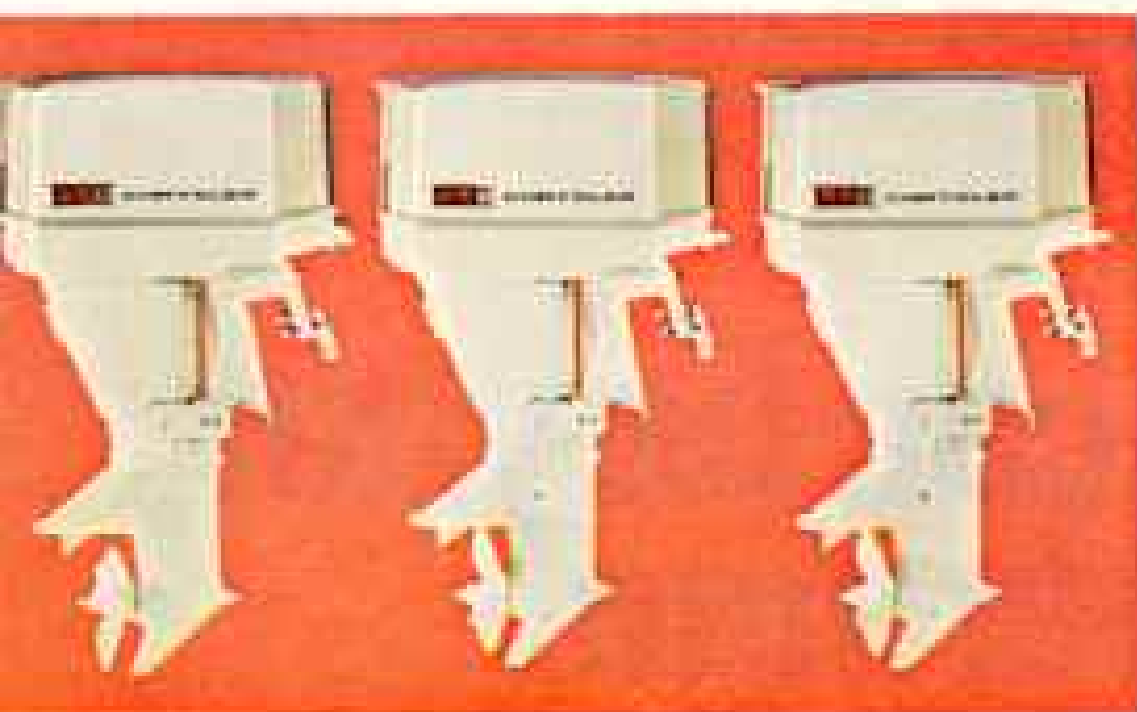

Fun-engineered Chrysler outboards! 35-, 45-, 55-hp. outboards . . . newest in Chrysler's great line.



Greatest choice of I/O power ever! Chrysler 80 and 175 . . . 2 new ones in Chrysler's I/O line.

GET MORE GOING FOR YOU WITH CHRYSLER!



CHRYSLER
Outboard
Boats
Marine Engine

SEE THE CHRYSLER CREW

They're your Chrysler marine dealers . . . you'll recognize them by this sign.

When Chrysler know-how hits the water, things happen.

Things like our all-new 14' to 23' Hydro-Vee runabouts, with their remarkable blend of hydroplane speed and Deep-V seaworthiness . . . of rakish beauty and broad-beamed roominess. More room, more stability, more seat—more fun per foot. That's the story of all Chrysler boats, aluminum or fiberglass, from 12 to 24 feet.

Things like our all-new 35, 45, and 55 fun-engineered outboards . . . with their new styling, new quietness, new econ-

omy, new power. New thinking makes all 27 Chrysler outboards—from the 3.5 to the 105—more fun to be with.

Things like the unmatched range of power offered by Chrysler inboards and I/O's. There are nine I/O's, from the popular 80 and new 120 models to the 290, including a brand-new 175. Inboards start at 125, go all the way up to 335. New this year: V-Drives for V-8 inboards.

Get in on the fun. See the Chrysler Crew—the men who sell and service Chrysler Marine products.

SEE CHRYSLER MARINE PRODUCTS IN ACTION ON NBC-TV'S "TODAY" AND "TONIGHT" SHOWS

MARINE PRODUCTS GROUP



CHRYSLER
CORPORATION



discover real travel adventure

Want to visit exciting new places? Or maybe you'd prefer sunbathing in Florida or relaxing beside some inviting stream? Perhaps you know a road somewhere you'd like to follow to the end. It's all the same with an Airstream Land Yacht...good beds, bathroom, hot and cold water, refrigeration, heat and light independent of outside sources wherever you go—for a night, a week, or a month. Airstream Land Yachting means real travel independence—no time-tables, tickets, packing. You just tow your Airstream lightly behind your car and follow your travel whims wherever they urge you to go. Yes, it's the exciting, better way to travel anywhere in the world. For extra fun join a Wally Byam Caravan.

write for free new color catalog—Thrilling as a world cruise

AIRSTREAM TRAVEL TRAILERS

AIRSTREAM INC. 10 CHURCH ST., JACKSON CENTER, OHIO • 12804 E. FIRESTONE, SANTA FE SPRINGS 10, CALIFORNIA

For \$12.95* you can be your own weatherman.



Put this new "Weather Station" on your desk or wall and you're in business. It's not one instrument. It's three! You get a barometer, a thermometer and a humidity meter. With brushed aluminum, aeronautical-type dials. And weather-change indicators.

Want to buy them separately? You can. From just \$3.98*. Also available: the "Comfort Meter," that gives you the THI (temperature-humidity index). Only \$9.98*. Very useful. All to be had at a drug, department, hardware or jewelry store near you. Superb buys! You will be well-pleased. That's our prediction.

Weather-Mates by WESTCLOX

GENERAL TIME

*suggested retail price

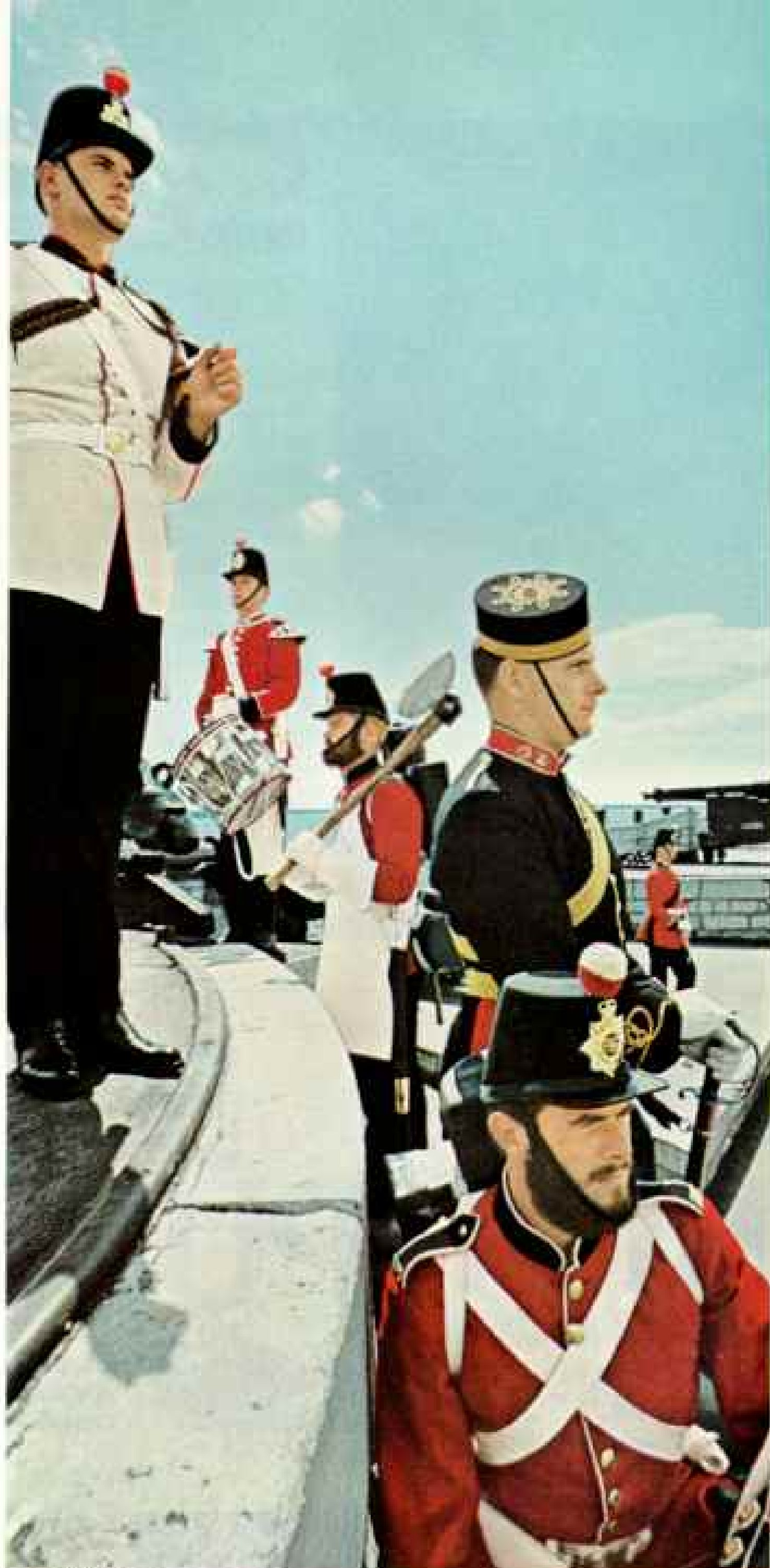

Friendly, Familiar, Foreign and Near

At massive and historic Fort Henry, authentic musketry drills and fiery cannonades are a thrilling spectacle. It's just one of the ways Ontario is so excitingly different. A less-crowded land. Steeped in British traditions. Naturally blessed, yet with bright lively cities. And, this year, all agog with Canada's Centennial celebrations. Join us, won't you? We're within easy reach. But first, let us send you our beautiful book: 52 pages of full-colour pictures and detailed text reveal the vibrant spirit of Ontario . . . Land of Great Adventure Vacations. Just write: Department of Tourism & Information, Room 29, Parliament Buildings, Toronto.



ONTARIO
Canada





New 14-ft. fishing lure. (Only \$455!)

*V.O.E. Goshen, Indiana
Mississippi, Kansas
16 foot model also available.

The new Mariner V is a totally new kind of boat. We call it a sportabout. ■ Use it for fishing, skiing, scuba diving or picnicking. Because she's made of lightweight marine aluminum, all you need is a thrifty 20-horse motor. ■ And what a ride! Her exclusive concave vee-lapstrake aluminum hull delivers a soft, smooth ride that coddles the ladies and planes beautifully when pulling skiers. ■ Write Starcraft Corporation, Dept. 7NG-3, Goshen, Indiana, for your free copies of the 1967 Power Boat and Sailboat Catalogs, Camper Catalog available, too.

**Take of
like in a
STARCRAFT**

Cruisers, Runabouts, Sportabouts, Fishing Boats, Sailboats and Campers

Adventure to AFRICA

WITH UTA FRENCH AIRLINES

on an "African Highlights" or "Cape to Khartoum" Safari. Visit wild game reserves, Victoria Falls, native bazaars, fabled cities. 37 to 59-day all-inclusive tours... on the airline that knows Africa best, UTA French Airlines.

Send for complete information:

	FRENCH AIRLINES 530 W. 6th Street Los Angeles, Calif. 90014
	Please send information on UTA Africa Tours to:
Name _____	(Please print)
Address _____	
City _____ State _____	
My Travel Agent is _____	
	NG/AF-2

BE PUSHY



It's the most convenient way to show your movies and slides.



Push the button and Da-Lite's fully automatic Electrolet® projection screen goes down. And up. And out of sight. Hangs on wall, ceiling or within the ceiling. And comes in 3 sizes and your choice of magnificent Da-Lite screen surfaces. Prices? They start at less than \$55 (50" x 50" model). For information write Dept. N.G.

DA-LITE

DA-LITE SCREEN CO., INC., WARSAW, INDIANA



Typical Pacific sunset



Watch Mountland light up



Spring desert bloom: wild oranges

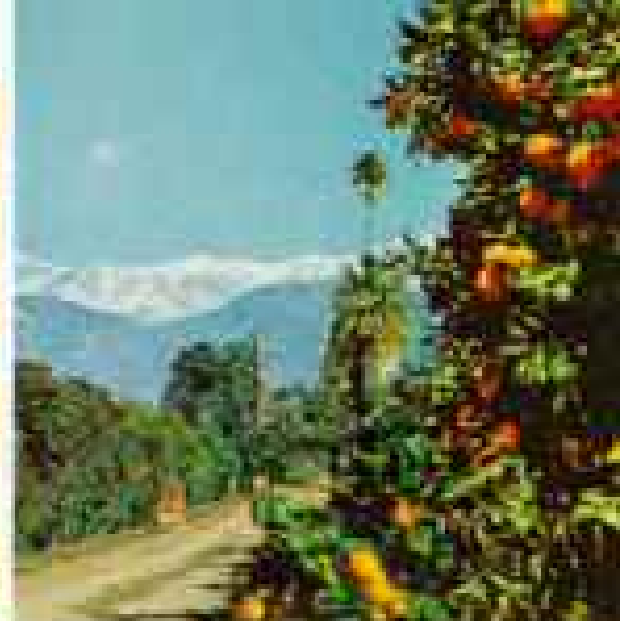

Oranges next to snow



Subtropical shopping



Living it up on the desert



Southern California park



Striking Music Center



A mission old as the U.S.



Big Santa Monica Bay

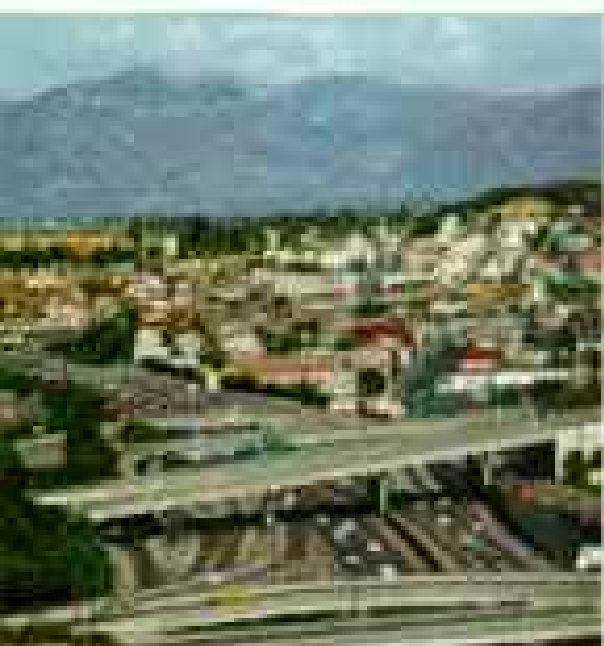

Exciting Los Angeles



A desert scene (it's no mirage!)



Pacific surfer pits his skill against a wave . . . and wins

All this at hometown prices

All four seasons are vacation seasons in Southern California. That's unusual, but good. With visitors coming out here all around the calendar, we can afford to be reasonable. Most hotels, motels, restaurants and shops charge about what you'd pay at home. Yet look at all there is to see and do!

Why not mail the coupon now?

Southern California

Free! Official Sightseeing Map. Full-color guide to hundreds of Southern California attractions.

All-Year Club, Dept. NG-3
105 West Seventh Street
Los Angeles, California 90017

Name _____
please print

Address _____

Zip _____
All-Year Club of Southern California. This advertisement approved by the Los Angeles County Board of Supervisors for the cities of Glendale, Inglewood, Hollywood, Long Beach, Los Angeles, Pasadena, Pomona, Santa Monica, Torrance. All other communities.

Vocational

KATHARINE GIBBS OUTSTANDING secretarial training for high school, private school graduates. Special course for college women. Residences, Catalog. Asst. Dean, 21 Marlborough St., Boston 02116; 200 Park Ave., New York 10017; Montclair, N.J., 87042; 77 S. Angel St., Providence 02906

McConnell Airline School

Be an Air Hostess, Romanist Travel! Adventure! Fast Train for exciting flight and ground positions. Airline-trained teachers. Free placement service. 2nd year. Catalog (give age). 1838 Nicollet Ave., Room N-37, Minneapolis, Minn. 55403.

Camps

ADIRONDACK WOODCRAFT

Fun and adventure for boys 7-16. Six age groups. 2 private lakes near Old Forge. Pack-horse & canoe trips. Hiking, Forestry, riflery, fishing, Tutoring. Mature counselors. Nurses. 2nd yr. Hlt. Wrs. H. Abbott, Box 2374, Fayetteville, N.Y. 13606

BAYLOR CAMP NEAR Signal Mountain. Six weeks \$150.00. Boys 8-15. Use BAYLOR SCHOOL dorms, dining room. Modern facilities. Full sports—riding, swimming, boating. Crafts. Overnight canoe. Smoky Mountain trips in historic Tennessee. Booklet. 183 Cherokee Road, Chattanooga, Tennessee 37401

BRUSH RANCH Girls & boys. Separate centers. On Pecos River, 12 miles from Santa Fe, N.M. Mountain climate. Riding (Western & English). Swimming. Pack trips—Drama, Dance, Art, Fencing—All Sports. Individual attention. Booklets. Write: Mr. & Mrs. Newcomb N. Rice, Terrea, New Mexico. 87573



AN IDEAL VACATION

4 separate camps. Emphasizing initiative, promptness, courtesy. Excellent facilities. All food, water sports: SCUBA, water skiing. Academic courses. NAVAL (days 14-18). Sailing, boating, naval training & drill.

HORSEMANSHIP (days 14-18). Equestrian, polo, jumping-under experts. GIRLS (14-17). Sailing, theater, equestrian, music, dance. WOODCRAFT CAMP (days 9 1/2-14). Archery, Indian & nature lore, campcraft, optional academics. 37 Lake Shore Ter., Culver, Ind. 46511

FARRAGUT NAVAL CAMPS

ADVENTURE on Toms River for boys 9-16. Sailing emphasized. Highest boat incl. 33 sailboats. Trips on 43-ft. flagship. Music, 2 gymnasiums, tennis fields. Pool. Appr. summer school. Ctg. Farragut Naval Camps, Box LC, Toms River, N.J. 08743

CAMP HIGHLANDER HIGHLANDER, N.C. Coed. 9-13. Highest camp in eastern U.S. 3, 4 or 5 wk. sessions. Riding, water sports. Trips. Private lake. Cabins. Academic work out. Owned, operated by Pine Crest School. Write: Larry N. Pedicard, Dir., Pine Crest School, Ft. Lauderdale, Fla. 33309

THE HOSTEL TRAIL To England and Scotland—a summer of bicycling, fun and adventure; interesting, capable British leaders; excellent supervision. July 8-Aug. 28, 1967. Separate groups for boys, girls, ages 14-18. 2nd Yr. Brochure: LEONARD HAERTTER, 600 S. Price Rd., St. Louis 24, Mo.

CAMP NAGAWICKA Girls 9-16. All camp and school activities. 18 sports: riding, sailing, tennis, golf, ballet, arts. Accred. Summer School. Math. Eng. wt. mt., typing, lang., reading lab. No. Chicago, Milwaukee. Guest house. Brother camps. Catalog: Gavin A. Pitt, Box N-13, Delafield, Wis.

QUANSET SAILING CAMPS

Grades 7 to 13. Cape Cod camp featuring daily sailing in Pleasant Bay. Racing, Swimming, Tennis, Canoe. Archery. Hiking included in fee. 3 age groups & C.T. Adult Sailing School June & Sept. 4th yr. N. Bruce Hammett, So. Orleans, Mass. 02662

CAMP ST. JOHN'S BOYS 9-18. Camp, school activities. On lake. 27 sports: riding, sailing, tennis, golf, canoeing. Accred. Summer Sch. Math, English, wt. mt., typing, language, reading lab. No. Chicago, Milwaukee. Guest house. Sister camps. Catalog: Gavin A. Pitt, Box N-13, Delafield, Wisconsin

TED WILLIAMS BASEBALL CAMP

Boys 8-18. Various Clinics & Programs Featuring Baseball & Basketball. Ted Williams in person. BJ Cassidy—Dept. NG, Lakeville, Mass. 02346

TYROL PROGRAMS ABROAD

1 TOUR Western Europe—Live in Tyrolean Alps. Mountain climbing at 12,000'. Alpine guides. 11 STUDY French in French village—TOUR France. Coed 13-18. 25 ea. group. D. N. Reich, 8828 Burning Tree Rd., Washington, D.C. 20034

VALLEY FORGE MILITARY ACADEMY SUMMER CAMPS

A summer of recreation in honor of America's National Shrine. Ranger Camp (13-14). Pioneer Camp (10-12). Training in leadership and courtesy. Optional tutoring and developmental reading. Sport Karting! Band Camp (13-18) under musical director. Individual instruction. Box 260, Wayne, Pa.

College

TRI-STATE COLLEGE For a professional career. Graduates in important posts in engineering and business administration. Placement outstanding. Accredited. Excellent faculty. Small classes. Four-quarter year permits degree in three years. Catalog. 1437 College Ave., Angola, Indiana 46703

VERNON COURT JR. COLLEGE 2-yr. women's college. A.A., A.F.A., A.B.S. Degrees. Excellent transfer record. Program designed for developing intellectual interests. Lib. arts, music, art, painting, home ec., sci., and soc. Sci. Sports. Pres. Sec'y., Bellevue Ave., Newport, R.I. 02842

Coed Schools

EDUCATIONAL HOLIDAYS® EUROPEAN & WESTERN TOURS America's Largest Student Travel Organization

ARISTA STUDENT TRAVEL ASSOCIATION
505 FIFTH AVENUE - NEW YORK, N. Y. 10017 MU 8-2330

ELGIN ACADEMY Grades 7-12. Coed. Accredited. Personalized guidance with individual PAR goals stimulates academic progress. Modern dormitories, gym, indoor pool, art gallery. Developmental reading. Est. 1926. Catalog: Frank Limacher, Dir. of Adm., 117 Academy Plaza, Elgin, Illinois 60120

HOWEY ACADEMY Fully accredited boarding prep. Grades 7-12. Near Orlando, Florida. Individual instruction, horsetack riding, supervised study, private beach, all sports. All air conditioned. Summer session. For catalog write: Dr. C. N. Vaughn, Jr., Hdm., Howey-in-the-Hills, Fla.

Interlochen Arts Academy

Accred. coed college prep. Grades 9-12. Equal emphasis on arts & academics. Music, Art, Drama, Dance. Small classes. Academy affiliated with New Guild Music Camps. Catalog: Dir. of Adm., Rm. 28, Interlochen Arts Acad., Interlochen, Mich.

JUDSON ARIZONA
COED BOARDING-COLLEGE PREP

Informal Western life. Accredited. Wider horizons in Jured Sun Country near Phoenix. Grades 9-12. Small classes. Semis-trips. Pool. All sports. Riding included in tuition. Art. Music. David N. Wick, Hdm., Judson School, Scottsdale, Ariz. 85252

PEACHAM ACADEMY Est. 1706. Grades 9-12. Coed prep in exceptionally beautiful area of rural Vt. College prep, gen'l. business courses arranged to meet indiv. needs. New housing, wt. lab. 50-ton ice creamery. Most tuition. Catalog: R. M. Powder, Jr., Hdm., Peacham, Vermont 05862

WEST NOTTINGHAM ACAD. Fully accredited Coed. College Prep. Grades 9-12. Personalized. Advanced math, English, science, history and Guidance. Sports, golf. Boy-women Phila-Balto. Est. 1744. Camp & Summer School. Catalog: N. C. Farnhof, Hdm., Box 11, Colona, Md.

WESTTOWN A FRIENDS' school. Prepares boys and girls for college under the moral and spiritual standards of Quaker education. Grades 9-12. Apply now for 9th or 10th grade, September 1968. Established 1709. Catalog: J. Kirk Russell, Dir. of Admissions, Box 653, Westtown, Pa. 19380 (near Philadelphia)

Home Study

CALVERT SCHOOL If you plan to live abroad, you can educate your child with approved Calvert home-study courses. Kindergarten—8th grade. Step-by-step teaching manual. Used by tens of thousands. Ideal for superior child. Non-profit. 8th year. Catalog: J. E. Tuscany Rd., Baltimore 10, Md.

Girls' Schools

BARTRAM IN FLORIDA Boarding & country day. Girls, grades 7-12. College prep of highest standards. Fully accredited. Music, art, dramatics. Air-conditioned dorms. Pool & ocean swimming. Tents, Dances, Booklets. Olga N. Pratt, 2264 Bartram Rd., Jacksonville, Florida 32207

CHAPEL HILL SCHOOL Est. 1837. Boarding & Day. Co. 9-12. Col. Prep. Gen. Courses. World-wide enrollment of 100. "How-to-Study." College Board Review classes. Country atmosphere. Boatop-10 m. Also, Summer Session. Catalog: 327-N Lexington St., Waltham, Mass. 02154

ST. ANNE'S SCHOOL Girls. Episcopal. Grades 8-12. Strong Liberal Arts College Preparatory. 97% grads. enter college. Art, music, modern dance. Riding, tennis. New labs, doctus. library. Use U. of Va. cultural resources. 300 yr. Margaret M. Jefferson, Charlottesville, Va. 22901.

Boys' Schools

ADMIRAL FARRAGUT ACADEMY Fully accredited. Grades 7-12. Prepares for all colleges, gen'l. academies. Naval Jr. ROTC Guidance. Near Gulf beaches. Pool, gym, tennis, lunch. Catalog: Admiral Farragut Academy, Prin., Box 11448, St. Petersburg, Florida 33713



AUGUSTA MILITARY ACADEMY

Fully accredited preparatory school features counseling, small classes, Military training, sports. Known as "The Friendly School." Grades 7-12 & P. G. New Junior School barracks, science & language labs. Tuition \$1300. Normilitary Summer School. Catalog. Superintendent: Box N-1, Fort Belvoir, Virginia 24437

BOLLES OF FLORIDA

FULLY accredited. Sound basic academic preparation. Grades 7-12. Developmental Reading. Study Skills. College Boards. Advanced Placement in English, Math & Biology. Guidance. Variety and instrumental sports for all. Year-round golf, tennis, sailing. Outdoor swimming pool. Catalog: Director of Admission, Box 10149-N, Jacksonville, Florida 32207

BORDENTOWN MILITARY

FULLY accredited. Grades 9-12. Outstanding record of college entrance. ROTC. Boys learn how to study. Small classes. Summer session. Sports for all. 9th year. Catalog: Bordentown Military Institute, Box 653, Bordentown, N.J. 08506

Brandon Hall
EXCLUSIVELY INDIVIDUAL CLASSES

Complete High School Curriculum Tutoring for All Schools and Colleges

SPECIALIZING IN HIGH I.Q. Customized Courses and Assignments

2503 Sandring Drive Grades 6-12
Dunwoody, Ga. 30043 404-487-2963

THE BULLIS SCHOOL

4 miles from the White House. Wm. F. Bullis, U.S.N.A. 24, Pres. Annapolis, Md. West Point, Md. Registrar

ANNAPOLIS WEST POINT
COLLEGE PREPARATORY

Accredited. Outstanding success. Complete athletic program. Summer term—June 18. Write for catalog.

CARDINAL FARLEY MILITARY ACADEMY. College preparatory. Grades 9-12. Conducted by Christian Bros. Accredited. Army ROTC. Daily guidance. Good college admissions record. New field house, pool, science lab. Sports, activities. Catalog: 24 Martin Rd., Rhinecliff, N.Y. 12574

CARSON LONG

MILITARY School. Educates the whole boy—physically, mentally, spiritually. How to learn, how to labor, how to live. Prepares for college and life. Grades 6-12. 11th year of character building. Overall charges \$1750. Box 21, New Bloomfield, Pa.



CASTLE HEIGHTS

Outstanding College Preparatory School
88.51% of 1966 graduates in 63 leading colleges and universities. ROTC Honor School in beautiful Andy Jackson country. 300-acre campus. 17 buildings, golf course, tennis courts. Every child in athletics, taught to study and excel. Fully accredited. Founded 1903. Jr., Sr., Post-Grad schools. Summer Program. Write: Box 387N, Castle Heights Military Academy, Lebanon, Tenn.



COLUMBIA MILITARY ACADEMY

Combines academic excellence with stress on character, leadership. Accredited prep. for College, Post-Graduate. Excellent records. D.E. 1966 ROTC. Superior staff. Outstanding records. Head of sports. In school, High School, P.G. New sports club. Summer school. For Cat. and "67 Future." write: CMA, Dept. N, Columbia, Tenn.

CULVER On Lake Maggiore. Develops initiative, self-reliance, confidence. Grades 9-12. Thorough college preparation. Accredited. Exceptional facilities. Leadership training. Black Horse Troop, Artillery, Infantry, Band, ROTC. Sports. Scholarships available. Catalog: 29 Pershing Ter., Culver, Ind. 46511

ADMIRAL FARRAGUT ACAD. Fully accredited. Grades 7-12. Prepares for all colleges, post-grad. acad. Testing guidance for college, career. Naval Jr. ROTC. Pool, tennis, boxing, bands. Summer camp, school. Catalog: Adm. Farragut Academy, Box L, Toms River, N.J. 08741

FISHBURNE MILITARY A State academic school with fine military tradition. Offering complete preparation for college—80% of graduates accepted. Grades 9-12. Fully accredited. Sports. Summer School June 28—August 12. Catalog: Col. E. B. Young, Box N, Waynesboro, Va. 22988



Florida Air Academy

Color catalog details sound academic program. Developmental reading & study skills. Small classes. Personal guidance. Accredited college prep grades 9-12 in Melbourne, Fla. 199 in Ft. Lauderdale. All sports. Flight optional. Summer school. Write: Florida Air Academy, Melbourne 2, Florida 32901

Florida Central Academy

Grades 7-12. Small classes. "In the land of the sun" 20 mi. north of Orlando. Fully Accredited College Prep. 30 acre campus. Outdoor Pool. Golf course. Athletics for all. Expert coaching. Experienced instructors. Colorado Summer School. Catalog, Dean, Box 38, Sorrento, Fla. 32776



FLORIDA MILITARY SCHOOL

Grades 7-12. Bonding city. Accredited. Honor rated. Academic program stressed. ROTC. Athletics. Intramurals. Help-class. Remedial reading. Pool. Band. Rifery. Qualified faculty. Catalog: Col. Carl N. Ward, Hdq., DeLand, Fla. 32728

FORK UNION MILITARY ACADEMY

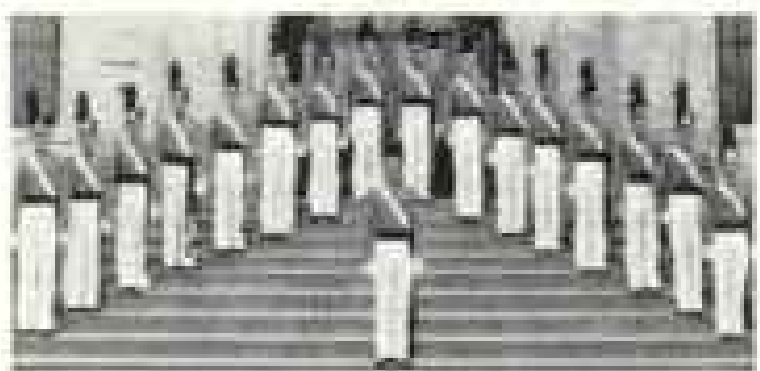

Our ONE SUBJECT PLAN of study in Upper School (grades 7-12) has increased honor roll 50%. Develops concentration. Fully accredited. 11 modern buildings. 4 completely equipped gyms. 2 indoor pools. Splendid surroundings. excellent health record. Junior School (grades 5-6) has separate buildings, gym, pool. Home-mothers. With your ONE SUBJECT PLAN builded and catalog write: Dr. J. C. Wicker, Box 383, Fork Union, Virginia 22855

GEORGIA MILITARY COLLEGE

Fully accredited Jr. College & 4-yr. prep school. 600 yr. Modern equipment. Personal guidance. Variety & intramural sports. Strong senior ROTC. Registration Dept., Jan., Mar. Write: Col. R. A. Thorne, Box N, Milledgeville, Georgia 31061.

GORDON MILITARY COLLEGE

Est. 1842. Fully accredit. Prep. grades 9-12 & Jr. College. No. ROTC. admissions granted. Dedicated faculty. small classes. supervised study. Sports. Russ 1100, Sumner School, Catalog: Col. Woodrow Light, Dept. N, Barnesville, Georgia 30704

GRAHAM-ECKES SCHOOLS

Coastal preparatory. Separate Boys' & Girls' Schools. Grades 7-12. Post Graduate. Fully accredited. Faculty rates 4-1. Full sports program. Reg. Write: Dr. Burtram B. Butler, Hdq., 650 N. County Road, Palm Beach, Florida 33480

GREENBRIER MILITARY SCHOOL

155th YR. THE SCHOOL OF ACHIEVEMENT
A Superior college preparatory school. Grades 7-12 and P.G. Fully accredited. College Boards. Learning How to Study emphasized. Small classes. Responsibility & Leadership developed. Business. Public Speaking. Band. Excellent Business records in College & Life. Athletics for all. 2,500 ft. Elev. Summer camp. Catalog: write: GMS Adm. Director, Box M-345, Lewisburg, W. Va. 24701

HARGRAVE MILITARY ACADEMY

Military training. Fully accredited. College preparatory. general courses. Grades 9-12. How-to-study training; remedial and developmental reading. All sports. Summer School. Est. 1908. Catalog: Col. J. H. Cosby, Box N, Chatham, Va. 24531

HOWE MILITARY SCHOOL

Jr. & Sr. Schools, grades 9-12 & 9-12. Thorough academic training in spiritual environment. Accred. prep. Sr. Basic ROTC. Jr. sports, dorm. Episcopal. Est. 1894 Summer Camp. Catalog: Col. R. R. Kelly, Supt., 537 Academy Pl., Howe, Ind.

KEMPER MILITARY SCHOOL AND COLLEGE

FULLY accredit. Grades 9-12. 2 year college. Small classes. Fine faculty. Counseling. How To Study Program. Jr., Sr. ROTC. Sports. Social activities. Flying Club. Education for leadership since 1884. Catalog: 779 Third St., Boonsville, Mo. 65211

KENTUCKY MILITARY INSTITUTE

Preparation for college under ideal climatic conditions. Two complete school plants. Fully accredited. Grades 9-12. Small classes. Special reading course. ROTC. Sports for all. Unless private military prep school in United States. Catalog: Director of Admissions, Box N, Lyndon, Kentucky 40222

MANLIUS

Since 1868 a superior college preparatory school for young men that effectively unites the finest elements of military and scholarly training. Grades 7-12. Professional Reading Clinic assures significant improvement in study skills. Write: Herbert G. Cantrell, Dir. of Adm., The Manlius School, 2 St. John Ave., Manlius, New York 13104 Tel: 315-682-2911

MARINE MILITARY ACADEMY College prep. Grades 9-12. Accredited. High academic standards. Marine Corps ROTC. Ideal winter climate. 140 acres. Military, leadership, physical training based on USMC traditions. B. Gen. John F. Dublin, USMC (Ret), Supt., 120 Two Jims Blvd., Harlingen, Tex. 76130

MARION INSTITUTE 116th year. Fully accredited Junior College. 4-year College Preparatory. Special preparation for Army, Navy, Air Force Academies. Senior ROTC. Small classes. Home System. Sports. Summer School. Catalog: Dir. of Adm., Marion Institute, Box N, Marion, Ala. 36756

MASSANUTTEN MILITARY ACADEMY

In the Beautiful Shenandoah Valley 90 Mi. S.W. of Wash., D.C. - U.S. Route 11
NATIONALLY ACCREDITED - ROTC
GRADES 9-12 & PG. SMALL CLASSES
Prof. Guidance - Reading Courses
Special College Entrance Program
Sports - Riding - Band - Pool - Gym
15th YR. - PICTORIAL CATALOG
Write Col. R. N. Beach, Pres., Box 11, Woodstock, Va. 22664

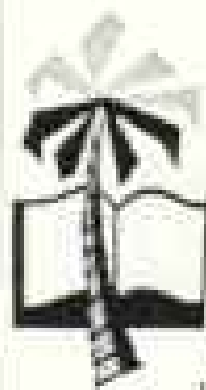

MIAMI MILITARY ACADEMY

FULLY ACCREDITED. ROTC HONOR SCHOOL. College Prep & General. Grades 6-12 & Post-Grad. 42nd yr. Class average 18. Guidance: HOW TO STUDY. Honors Courses. Flight training. Band. All sports. Pool. 80 acres. Modern facilities. Also Summer School & Camp. Catalog: 10607C Biscayne Blvd., Miami, Fla. 33138

MILLER SCHOOL OF ALBEMARLE

Military. Grades 7-12. College prep. plus industrial arts, iron & woodworking, auto mechanics, machine shop & electricity. Sports. 19th yr. Catalog: Col. W. H. Flannagan, Dept. N, Miller School P.O., Charlottesville, Va. 22901

MISSOURI MILITARY ACADEMY AND SEPARATE JUNIOR SCHOOL

76th yr. Fully accredit. College Prep. Grades 9-12. Small classes. fine teachers. Individ. achievement stressed. Guidance. Sr. ROTC. Sports: riding, golf. 280 acres. 2 new bldgs. in 18 yrs. Catalog: Col. C. R. Stribling, 937 Main St., Mexico, Mo. 65205

N. Y. MILITARY ACADEMY

Accredited prep school. Grades 7-12 & P.G. Expert faculty. challenging curriculum. Reading. small classes. New Science Bldg. advanced courses. Sports. Riding. 3 pools. Band. ROTC unit. 72 Acad. Ave., Cornwall-on-Hudson, N.Y. 12520

NORTHWESTERN MILITARY ACADEMY

Lays a solid foundation for a successful college career in a challenging academic atmosphere. Est. 1885. Accredited. Grades 9-12. Basic ROTC. Small classes. Sports, social, religious programs. Guidance, testing. Tutorial help. For catalog: 83 S. Lake Shore Rd., Lake Geneva, Wisconsin

OAK RIDGE MILITARY INSTITUTE

118th Yr. Fully accredited. Thorough college prep. Certified faculty. Grades 9-12 & postgraduate. Small classes. Individualized attention, guidance. Reading development. Sports. Band. ROTC. Catalog: Supt., Box N-67, Oak Ridge, N.C. 27318



EDUCATIONAL TROUBLE SHOOTERS

Individualized Plan—Each Student a Class

For those with educational problems—successful college preparation and general education. Our tests discover causes of difficulties and we (1) devise individualized program to overcome difficulties; (2) make up lost time; (3) instill confidence; (4) teach the art of concentration, and science of study. Faculty 14; Enrollment 40; 35 years' experience. Write: Edward R. Knight, Ph.D., Headmaster

OXFORD ACADEMY

Box G-95, Pleasantville, New Jersey

PEEKSKILL MILITARY ACADEMY

134 years successful college placement. Grades 7-12. Postgraduate program. Small classes. Self-discipline, responsible leadership developed. All sports; pool. Band. Catalog: Box N-3, Peekskill Mil. Acad., Peekskill, N.Y. 10568

Pine Crest School

Academic Excellence in Florida. Fully accredited prep. Boarding. grades 7-12. Grade over leading colleges. Sports, pool. Beautiful new campus. Coed. Est. 1914. Summer school, camp. Catalog: Director of Admissions, Box N, Pine Crest School, Fort Lauderdale, Florida 33308

THE SANFORD NAVAL ACADEMY

Florida's Outstanding Private School
Selective enrollment. Small classes. Arrangements and Ivy League permit study and excel. All sports program in latest modern campus. Accredited. Jr. and Sr. schools. Outstanding housing, academic facilities. Write: Box 367 N, The SANFORD NAVAL ACADEMY, Sanford, Florida



RIVERSIDE ★ MILITARY ACADEMY

A DISTINGUISHED MILITARY PREPARATORY SCHOOL

Nationally accredited college preparatory. Grades 9-12 and Post Graduate. Weekly reports. Two completely equipped schools provide ideal change of climate for health, interest and year-round sports. Constant association with selected teachers who live and eat with cadets.

College guidance. Honor ROTC unit develops self-discipline. Summer School in Blue Ridge Mts. 2nd new Gym & Activities Bldg. Boys 37 states. Reasonable, all-inclusive school charge. Catalog. Write: **GEN. SANDY BEAVER**, Pres. Box 303, Gainesville, Ga. 30501

**WINTER IN FLORIDA
FALL & SPRING IN BLUE RIDGE MOUNTAINS**

St. John's Military Academy

83rd
Year

College preparatory. Grades 7-12. Accredited. Stresses character, scholarship, leadership. Tutorial and accelerated reading program. Sports including tennis, flying, golf, intramural program. ROTC. Nominations. Summer camp, school. Milwaukee, 28 miles. For catalog, write: **Gavin A. Pitt, Pres.**, Box 1337, Delafield, Wisconsin

SAINT THOMAS ACADEMY

Grades 9-12 Prep for leading colleges & universities. Roman Catholic. Small classes. ROTC. Distinguished faculty. Academic, career & spiritual guidance. Sports. 6th yr. Catalog. **Box 2, Minn., St. Thomas Academy.** St. Paul, Minn. 55116

★ STAUNTON ★ MILITARY ACADEMY ★

In Beautiful Shenandoah Valley. Thorough college preparation. Fully accredited. Individual guidance. Band. All sports. 2 gyms. Food. Fine health record. Five-story buildings. Separate Junior School. 10th Catalog write: **Gen. S.M.A.** Box D-1, Staunton, Va. **LEADERSHIP, CITIZENSHIP & SELF DISCIPLINE STRESSED.** *Founded 1880*



V VALLEY FORGE MILITARY ACADEMY AND JUNIOR COLLEGE

"At the Nation's Shrine"

Valley Forge, hallowed shrine of American freedom, has loaned its cherished name to this fully accredited, distinguished military academy and Jr. College. Small classes, highest academic standards. Prep. School, grades 9 thru 12 and Junior College, regional accreditation. Personalized guidance and instruction in Reading and Speech Clinics. All varsity sports. 82 modern fireproof buildings, including two gymnasiums and hospital. Motorized Artillery, Cavalry, Infantry, Band, Senior Division ROTC. Send for Catalog. **Box M, Wayne, Pa.**

ROOSEVELT MILITARY ACAD.

"Battlers of Men." Accredited. Grades 9-12. Prep. general courses. Small classes. Emphasis fundamentals, how to study. Guidance. ROTC. Sports. Aviation. Catalog. **Col. Glen G. Milliken**, Box N, Alamo, Ill. 61211 Tel: 309-582-5166

SEWANEE MILITARY ACADEMY THIRD YEAR

Fully accredit college preparatory. Grades 9-12. Small classes, indiv. attention. Episcopal. ROTC. Highest rating. Sports; gym, pool. 16,000 acres. U. of South Ark. Summer School-Camps. Catalog. **Dir. of Adm.**, Box N, Sewanee, Tenn. 37375

SHATTUCK SCHOOL

Boys. Grades 9-12. Balanced educational, religious, military. Accredited college prep. General courses. Small classes. Sr. Basic ROTC. Sports. Gym, pool, golf, Episcopal. Est. 1938. Summer School. Catalog. **Dir. of Adm.**, 675 Shumway Hall, Faribault, Minn. 56003

VIRGINIA EPISCOPAL SCHOOL

Est. 1888. Grades 9-12 & P.G. Fully accredited. Through preparation for college. Religious instruction. Small classes. Daily athletics. In foothills of Blue Ridge Mts. Write: **Austin N. Montgomery, Jr.**, Lynchburg, Va. 24505

WENTWORTH MILITARY ACADEMY

Preparation for the rigors of business or higher education. Accred. 4-yr. High School, 3-yr. College, Sr. ROTC. New million-dollar field house. Golf, FAA flying. Summer School, younger boys' camp. 87th year. Catalog. **Col. Wilcox**, 837 Wash. Place, Lexington, Mo.

WESTERN MILITARY ACADEMY

Emphasis on self-confidence, self-direction, how-to-study. Small classes, guidance. Grades 7-12. Career analysis. Jr.-Sr. ROTC. Athletics; riding. 60th yr. St. Louis. Catalog. **Col. Ralph B. Jackson**, Supt., Box N-3, Alton, Ill. 62003

NATIONAL GEOGRAPHICS kept neat, clean, handy

Magazines and maps slip into these handsome files to become valuable library reference volumes. Look like fine books. Leather-like, book-red fronts beautifully embossed in gold. Now fadeproof. One file holds 6 issues or many maps. Includes gold foil for adding dates, etc. Money-back guarantee. Send check to THE HIGHSMITH CO., Fort Atkinson, Wis. 53538.



6 National Geographic Files
or 5 magazine files and one
map file _____ only **\$4.95**
(\$5.95 outside U.S.A.) **postpaid**

Catalog of files for 100
other magazines on request



126
WORLDWIDE
STAMPS
just released

ONLY
10c



RUSH REPLY and get 126 colorful stamps. From Africa, Europe, the Far East—NEW ISSUES: religious, animal, bird stamps from Colombia, Surinam, Nigeria, many others. OLD ISSUES: Mexico, Monaco, Maldiv Islands, more. Pictorial, airmail—odd shapes, sizes, everything. Plus exciting stamp selections from our Approval Service. Buy any or none, return in 10 days. Cancel anytime. PLUS color souvenir and story of World's Rarest Stamp. **GARCELON STAMP CO.**, Dept. NG 21, Calais, Maine 04819

stop on a whim . . .



NO NEED TO PHONE AHEAD FOR RESERVATIONS . . . No check-out time . . . the whole countryside is your playland when you travel in a Del Rey Truck Camper. Cook, eat, sleep, play wherever, whenever the mood moves you. Truly complete in every way, the Del Rey Truck Camper is designed for moderns on the move . . . who want to go and see more . . . who want practical convenience without compromise of quality or equipment.

Write today for free colorful brochure showing the many models Del Rey has created for your camping pleasure. Ask about the International Safari Tour Club.

Del Rey
INDUSTRIES, INC.



3936 Cassopolis St. • Elkhart, Indiana

Relax in

a State of

Excitement...

OREGON

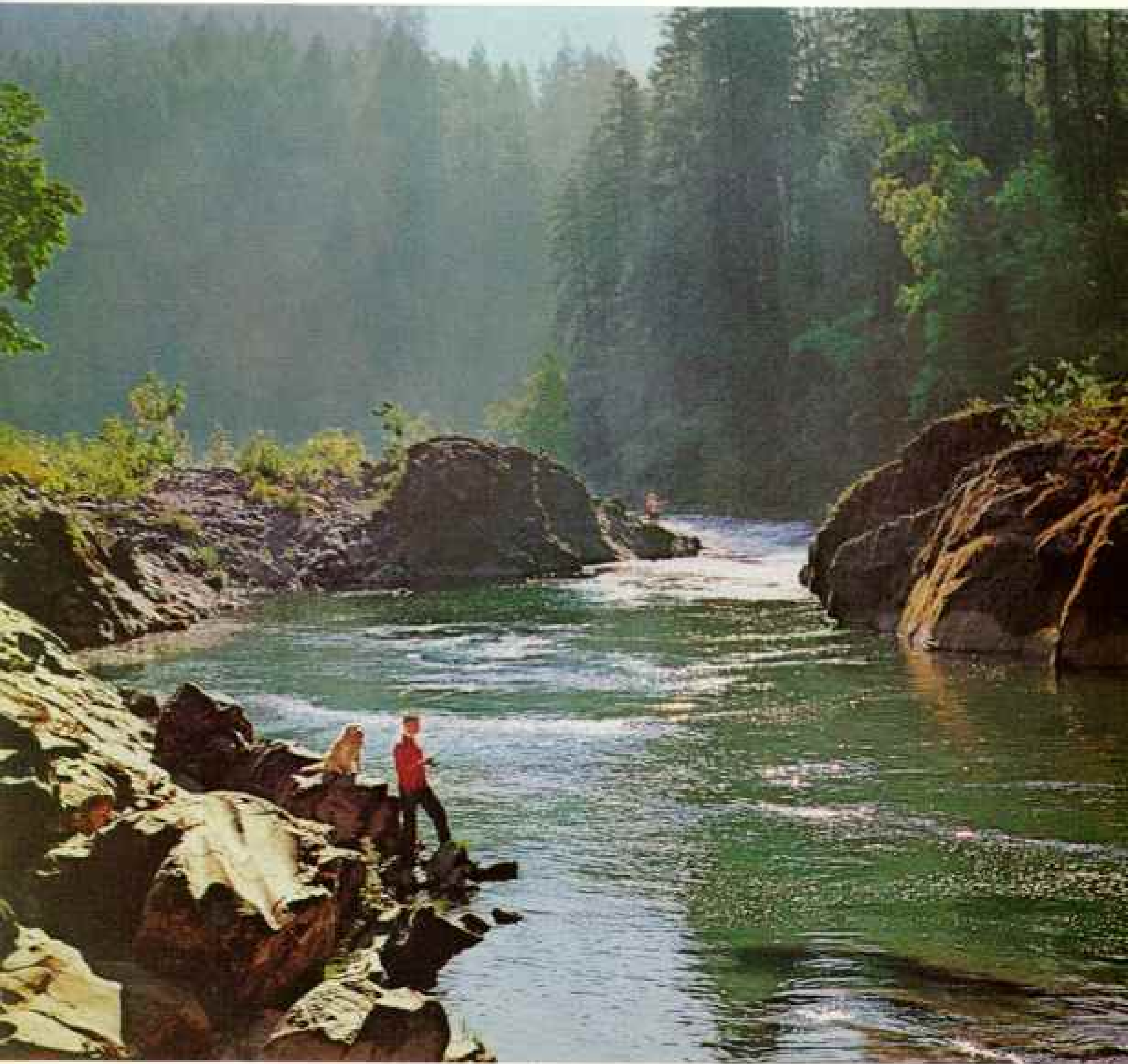

Oregon has a thousand private worlds like this—the North Umpqua River in southwestern Oregon. All are cool, green, refreshing. All exhilarating when tested with fly rod, boat, camera, or other vacation paraphernalia. There are sparkling streams set amidst lush forests and fern. Sunny high plateaus with hundred-mile vistas. White sand beaches that stretch into infinity. Unbelievably blue lakes. Oregon is a thousand *different* private worlds—accessible, uncrowded, and 97,000 square miles big. There are more than 11,000 public campsites, fine resort accommodations, great highways, too. Come see for yourself . . . *this summer.*

Vacation information available at several State border centers, 43 Certified Centers in Chambers of Commerce.



TRAVEL INFORMATION, Room 87
Highway Department, Salem, Oregon 97310
Please send me free:

- Color booklet, Oregon, Cool Green Vacationland.
- Highway map.
- Parks and camping guide.
- Oregon Events folder.

NAME _____

ADDRESS _____

CITY _____

STATE _____ ZIP _____



Our new V-100 has a split personality

Sure, this 100-hp motor takes off! But it is the Sea-Horse V-100's ability to do an about face and perform smoothly at the lowest idle that distinguishes it from all others.

The secret is revolutionary Power/Pulse Ignition — no breakers, no points, no condensers. This capacitor discharge system produces the smoothest power ever achieved in a two-cycle engine. Get instant starts plus incredible efficiency at low speeds because Power/Pulse cuts engine sensitivity to varying fuel-air intake settings. It shoots the juice to the spark plugs 20 times faster than coil and breaker systems. Besides eliminating breaker point wear

and replacement, this rapid-fire ignition virtually eliminates plug-fouling — vastly extends plug life.

Exclusive Electramatic drive, with single throttle-shift lever (included in the price of the motor) puts all the power in the palm of one hand. Johnson engineering makes this the fastest moving fuel miser of all outboards (on regular 50 to 1 gas/oil mix). Also makes it completely resistant to corrosion (no flushing out after running in salt water).

Check the V-100 and 17 other models at your Johnson Dealer's (in the Yellow Pages) . . . or write for free catalog. Johnson Motors, Waukegan, Ill. 60085, Dept. NG-37.

Johnson

Fast or Dependability — Sea-Horse motors, Sea-Foil boats, Air-Buoy skin diving gear, Sea-Horse accessories. Division, Outboard Marine Corporation

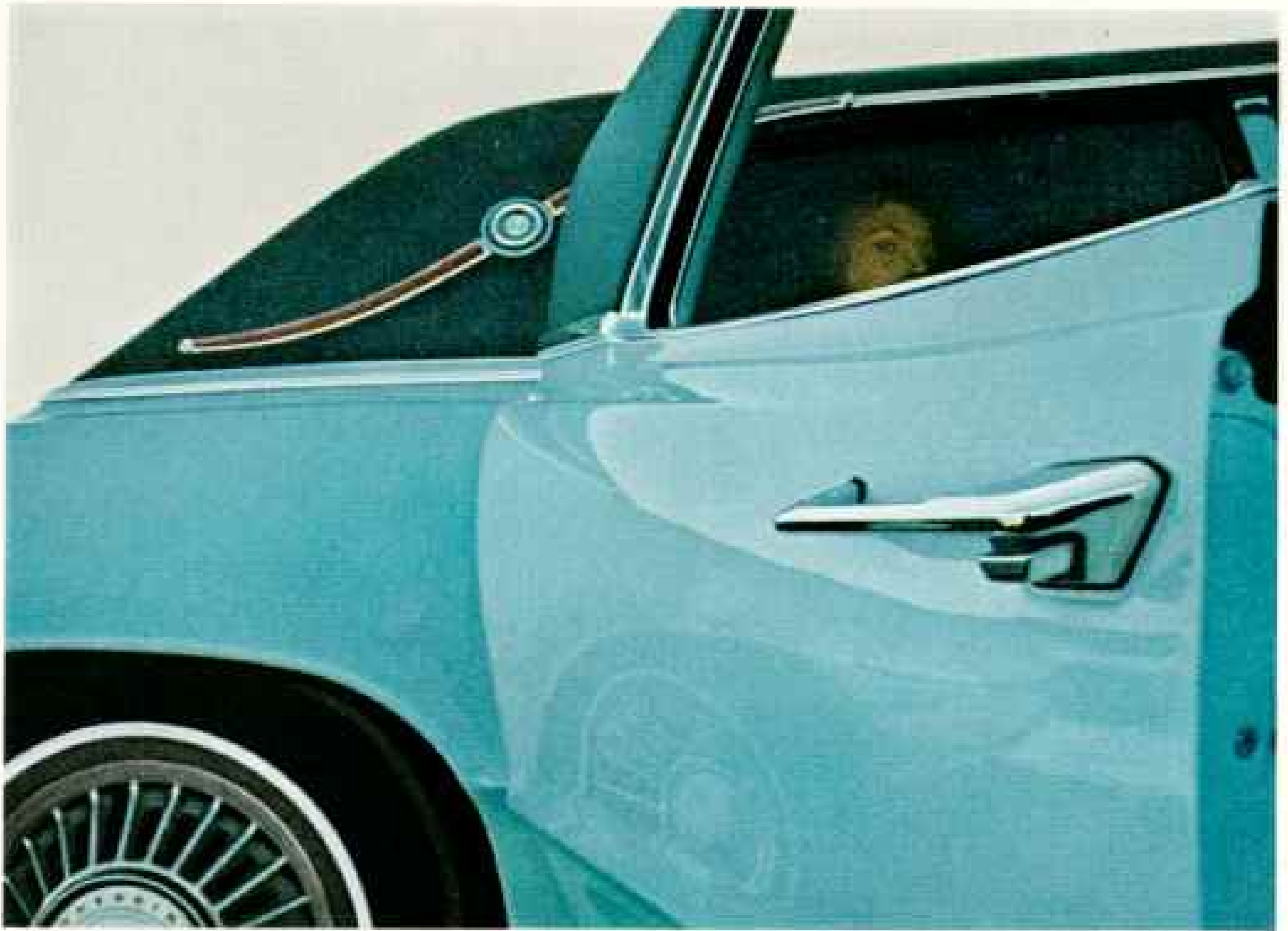

**What's so unique
about the new 4-door
Thunderbird?**

It's the one personal luxury car with four doors. The only one. Another better idea from Ford. Made especially for people who love Thunderbird's looks, but need the convenience of four doors. Now those people can fly, too. The new Thunderbird with Lincoln Continental-inspired center-opening doors makes it easy to escape from the ordinary. Drive the new four-door Thunderbird; decide for yourself whether it is as unique as we claim.

Thunderbird
Unique in all the world.



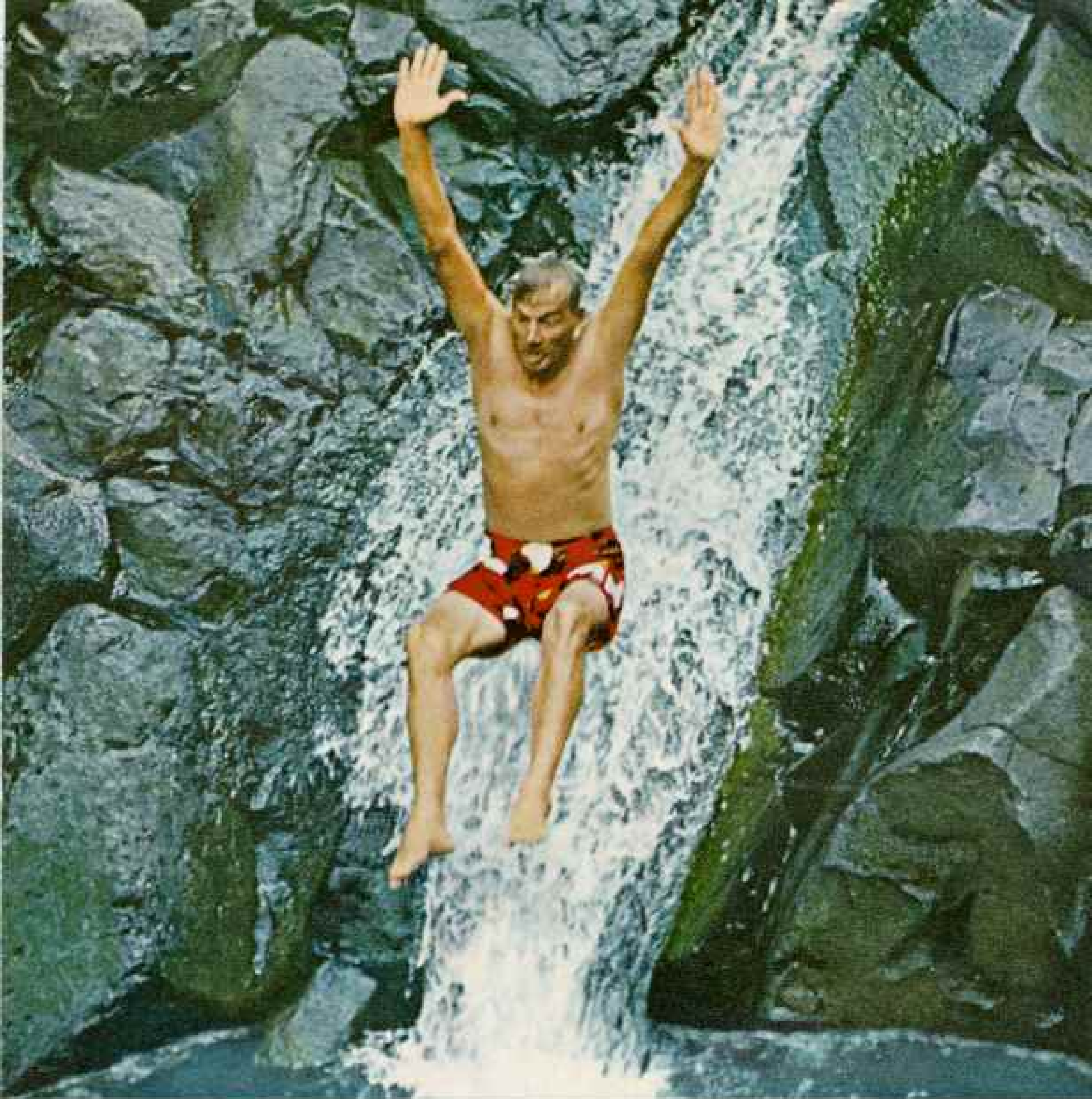

Nine years ago we sold Wally Gordon a round-trip ticket to Hawaii.

He still hasn't used the other half.

United knows how wonderful Hawaii is. That's why we made it so easy to get there.

Nine years ago, for example, our flights took a fast eight hours from the Mainland. 22 times a week.

Now we do even better. Only five hours from the Coast. Over 63 flights a week.

Use United's Credit Card and charge your whole trip—everything you arrange as a package with your Travel Agent.

Come on over. You don't have to stay nine years. Just long enough to slide down a stream, learn the hula, get a tan, catch a marlin, improve your golf, try the surfing...

Say hello to Wally.

I ran into this fellow named Gordon, and he told me the funniest thing.



*fly the
friendly skies
of
United.*